



# Series 2000 Garage Door Price List

01.01.2026

**HÖRMANN**



## HÖRMANN IS ALWAYS COMMITTED TO EXCELLENCE: “In Engineering, in User Safety and in Design.”

All our products are third party tested to the highest standards and are certified to the high safety requirements and performance characteristics of the European Standard 13241-1.

This gives you the reassurance that your purchase of a Hörmann product is a safe investment. We are also committed to our national network of Garage Door Specialist Distributors.

These are independent businesses, who believe in customer service and have skills to advise you on the best product for your property, also providing quality fitting and finishing.

**“A great product performs at its best when fitted by experts.”**

### Door Operating Systems

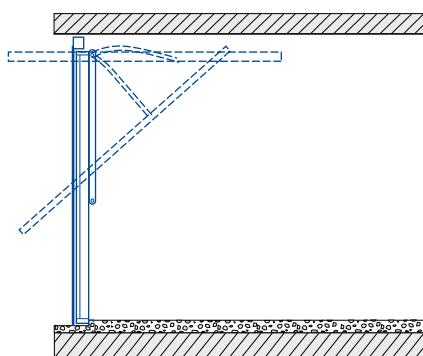

Canopy Operating Gear

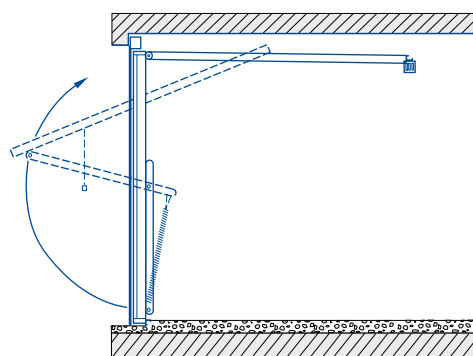

Retractable Operating Gear

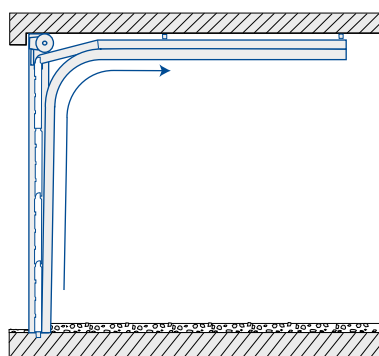



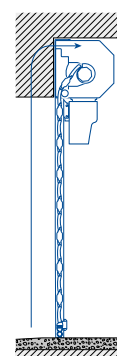

Sectional Operating Gear



RollMatic Operating Gear

We reserve the right to change specification without prior notification.

# Contents

	<b>Up-and-over garage doors</b>	Canopy and retractable with steel infill	6
	<b>Sectional garage doors</b>	Sectional garage doors LPU 42	14
		Double-skinned steel sectional doors	14
		Secured by Design	14
		<b>NEW.</b> Plaingrain surface finish	14
		Optional extras and window designs	19
	<b>RollMatic roller garage doors</b>	RollMatic	25
		RollMatic T	36
		<b>NEW.</b> New size range	36
		RollMatic OD	43
		RollMatic side doors	51
	<b>Door operators</b>	Garage door operators	54
		Operator accessories	54
		Hand transmitters	54

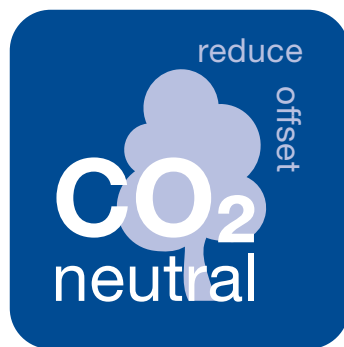

**WE THINK AND ACT GREEN.** As a family business, we are very conscious of our responsibility to future generations. The Hörmann climate protection strategy aims to reduce and avoid CO<sub>2</sub> emissions. We cover 100% of our electrical power needs at all European production locations with purchased green electricity. We are also investing in a clean future with other measures such as the use of recycled paper, CO<sub>2</sub>-neutral postal shipping, and the recycling of transport packaging to save more than 75,000 tons of CO<sub>2</sub> every year. We work with ClimatePartner to offset the emissions that we do generate by supporting certified climate protection projects. In particular, we offset all CO<sub>2</sub> emissions produced in manufacture of products for residential construction as standard.



# Measuring sheet

## For garage doors

Not for pre-fabricated garage doors!

Customer name: \_\_\_\_\_

Street: \_\_\_\_\_

Postal code / city: \_\_\_\_\_

Construction project: \_\_\_\_\_

Tel.: \_\_\_\_\_

Fax: \_\_\_\_\_

Mobile phone: \_\_\_\_\_

E-mail: \_\_\_\_\_

Date: \_\_\_\_\_

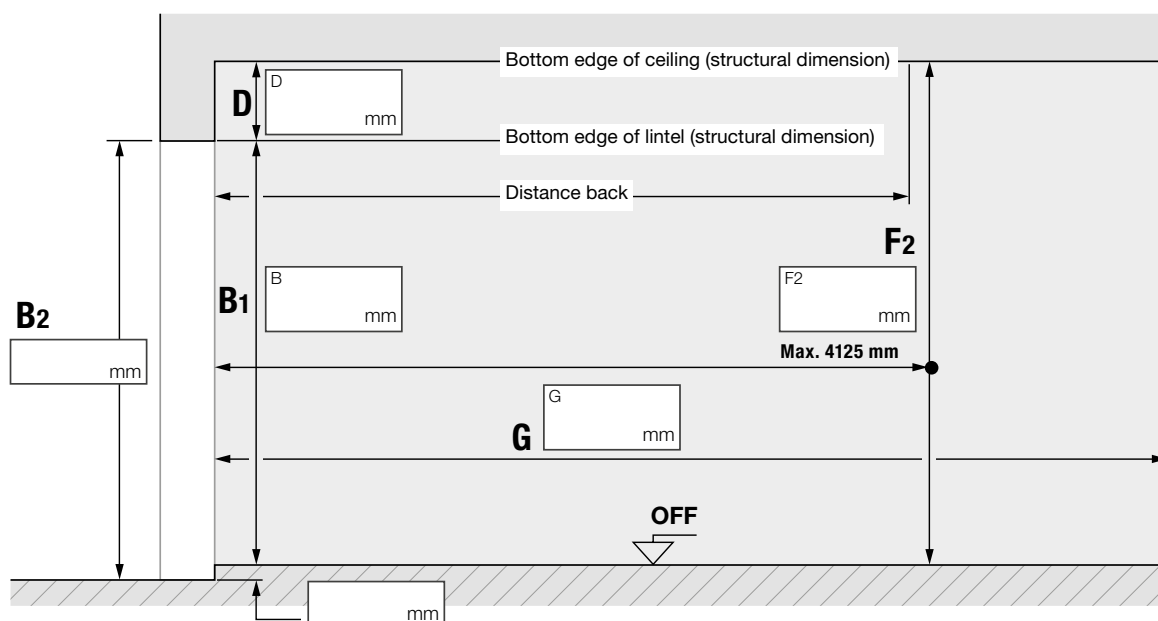
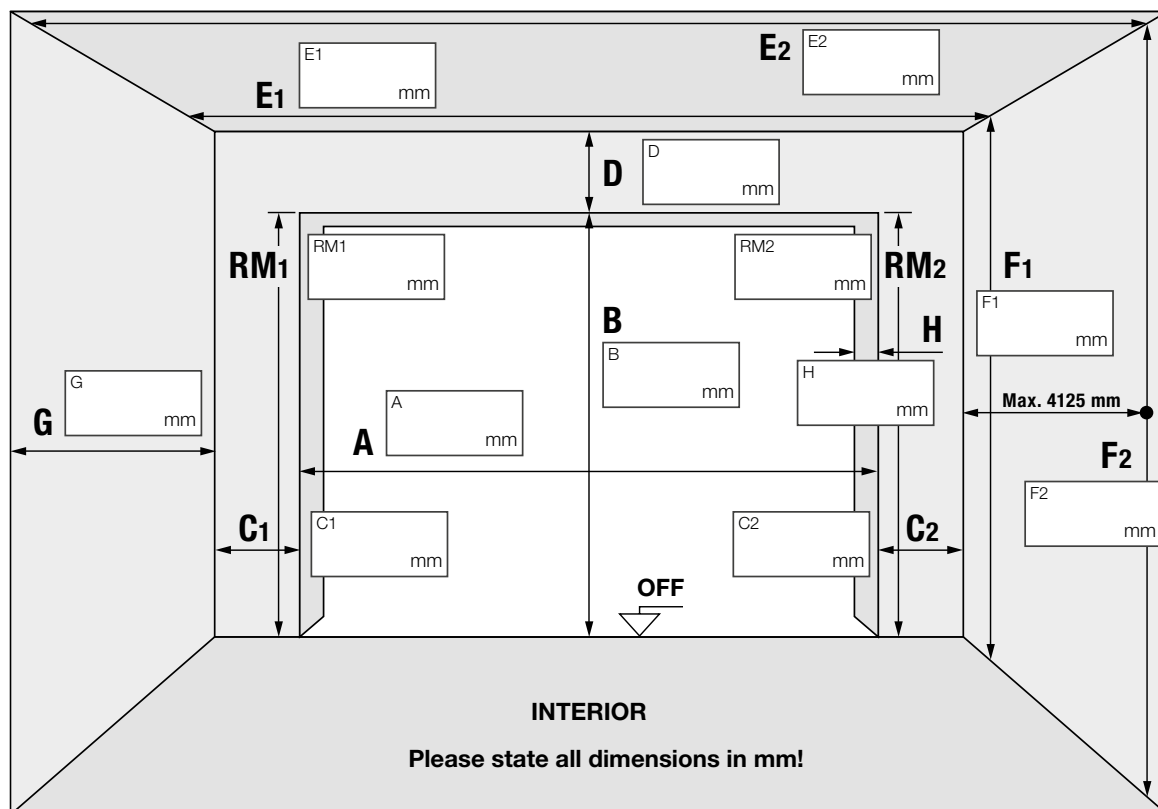

- |                      |                       |                      |                                  |                      |                               |                       |              |
|----------------------|-----------------------|----------------------|----------------------------------|----------------------|-------------------------------|-----------------------|--------------|
| <b>A</b>             | Clear width           | <b>D</b>             | Headroom                         | <b>F<sub>1</sub></b> | Ceiling height from FFL front | <b>H</b>              | Reveal depth |
| <b>B</b>             | Clear height from FFL | <b>E<sub>1</sub></b> | Interior garage dimensions front | <b>F<sub>2</sub></b> | Ceiling height from FFL back  | <b>RM<sub>1</sub></b> | Left grid    |
| <b>C<sub>1</sub></b> | Left sideroom         | <b>E<sub>2</sub></b> | Interior garage dimensions back  | <b>G</b>             | Building depth                | <b>RM<sub>2</sub></b> | Right grid   |
| <b>C<sub>2</sub></b> | Right sideroom        |                      |                                  |                      |                               |                       |              |



# Series 2000 Up-and-Over Doors



## Product description

### General aspects

Series 2000 doors are available with either canopy, retractable or retractable plus gear and an optional factory fitted steel frame or supplied for fitting to a timber sub-frame. For Series 2000 and side doors to align, further details are required.

### Door leaf

Steel leaf chassis with steel infill, infill or prepared for infill on site. Door leaf reinforced with 2 steel profiles.

**Single and double doors** with lateral UPVC weather seal as trap guard and sound absorber, fitted to the bottom part of frame and top of door.

### Style 2011 Open-for-infill:

Prepared for infill in the frame or overlapping the frame.

Infill weight:

**Single doors**

min. 6 kg/m<sup>2</sup>

max. 10 kg/m<sup>2</sup>

**Double doors**

min. 6 kg/m<sup>2</sup>

max. 10 kg/m<sup>2</sup> standard

View of infill in the frame:

**Single doors**

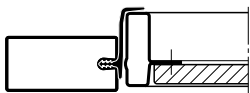

**Double doors**

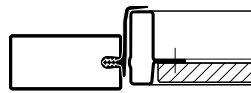

Max. infill thickness for infill overlapping the frame:

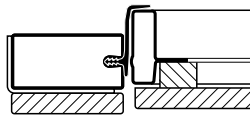

max. 17 mm

for **Single doors:**  
16 mm infill thickness  
+ 1 mm gap  
= 17 mm infill thickness

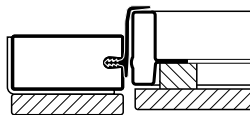

max. 17 mm

for **Double doors:**  
16 mm infill thickness  
+ 1 mm gap  
= 17 mm infill thickness

### Dimension of door leaf

**Single doors**

BR width - 58 mm

BR height - 10 mm

**Double doors**

BR width - 58 mm

BR height - 10 mm

### Steel frame

**Single doors:** Optional steel box section frame with horizontal tracks, pivot arms etc all pre-fitted.

**Double doors:** Optional steel box section frame with horizontal tracks, pivot arms etc all pre-fitted.

### Counterbalance

**Canopy doors** - Single torsion spring shaft fixed to the head frame with cable and rollers running in vertical tracks on the inside frame legs. Spring and vertical tracks incorporate spring and cable break safety system conforming to BS EN 12604.

**Retractable doors** - Multiple spring safety system: tight coils eliminate the risk of finger trap also conforming to BS EN 12604.

**Retractable Plus doors** - as retractable doors but with an increased clear drive through height (see data sheet for further information).

### Surface protection

#### Styles with steel infills:

Door leaf made of galvanised material, powder-coated in

- Traffic white, based on RAL 9016,

- Terra brown, based on RAL 8028,

Steel frame powder-coated in the same colour as door.

### Fittings and locking

Round plastic handle on the outside, plastic 'rotary disc' on the inside. Special lock with multi-point locking, with profile half cylinder and release button on the inside, 2-point locking by automatic UPVC-latch (adjustable) 4-point locking option also available.

### Standard

**Single doors** pre-assembled UPVC rollers and UPVC bushes in all door bearings and buffer stop.

**Double doors** track rollers with ball-bearing.

### Delivery

**Single doors** pre-assembled, 1 unit.

**Double doors** 3 units: door leaf, frame pack and accessories pack.

### Arrangement of fitting anchors

**Single doors**

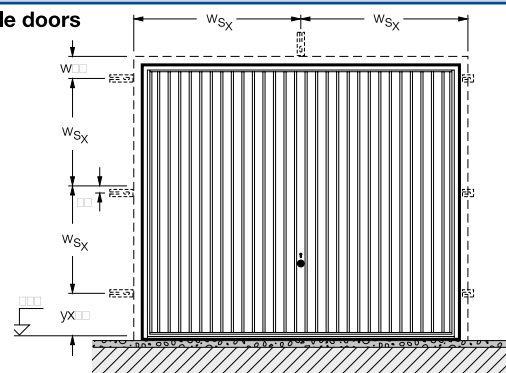

**Double doors**

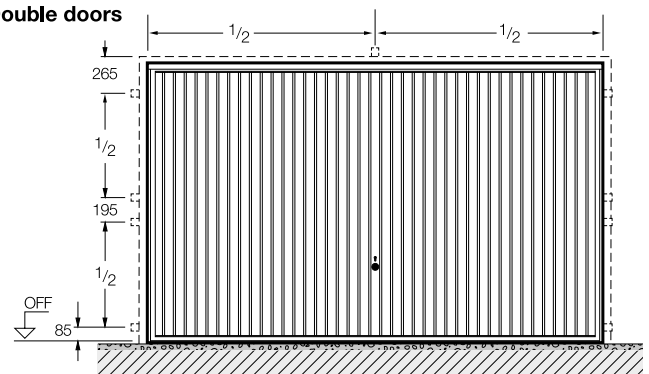

### • Note:

Series 2000 Doors do not include a bottom threshold rail as standard.

Doors can also be fitted to a 70 x 70mm nominal goal post frame (minimum 55mm wide for canopy doors).

# Series 2000 Up-and-Over Doors



## Product description

### Fitting behind the opening

#### Single

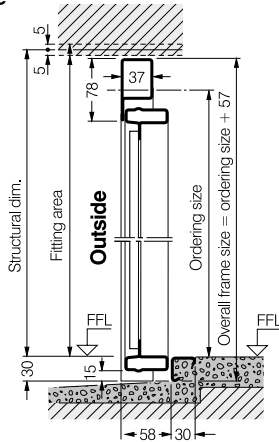

without threshold

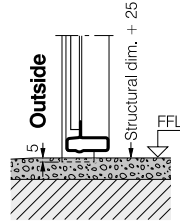

#### Double

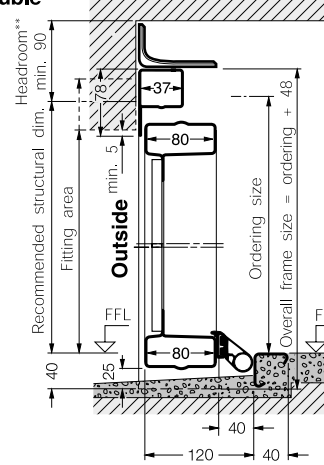

without threshold

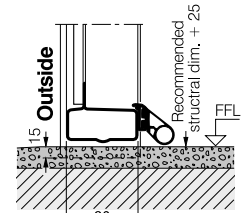

\*\* with operator SupraMatic E/P/H  
 Headroom for single door with steel infill min. 50 mm, with timber infill min. 65 mm  
 Headroom for double door with steel or timber infill min. 105 mm

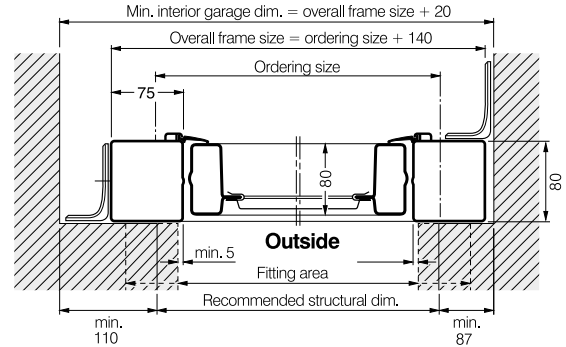
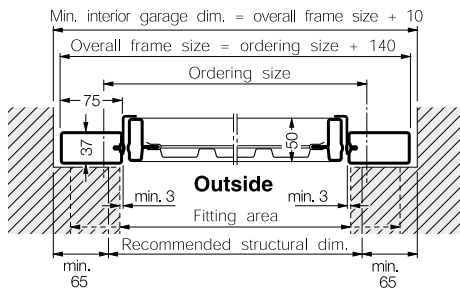

### Fitting in the opening

#### Single

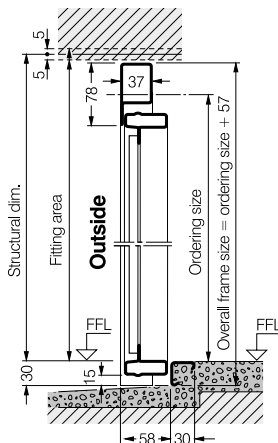

without threshold

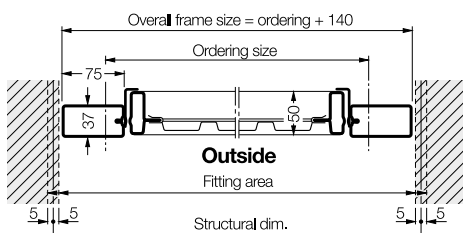
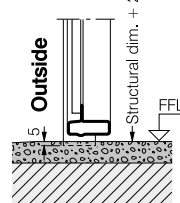

#### Double

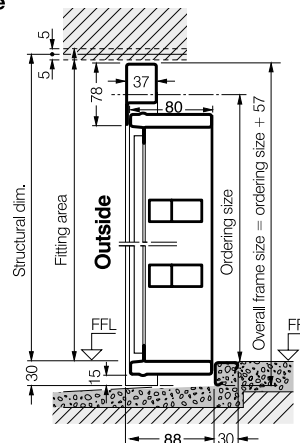

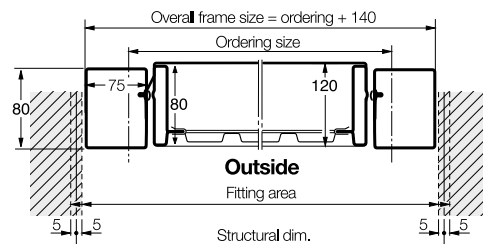
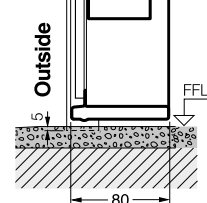

without threshold



# Hörmann Up-and-Over Doors

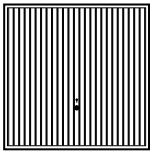
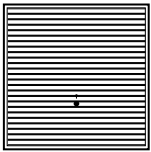
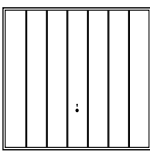
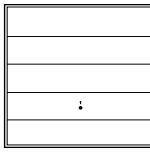

## Canopy & retractable with steel infill

SINGLE DOORS											
Door sizes BR		2001 Vertical		2002 Horizontal		2601 Elegance		2602 Finesse		2101 Ilkley	
Imperial	Metric	CAN.	RET.	CAN.	RET.	CAN.	RET.	CAN.	RET.	CAN.	RET.
6'6" x 6'6"	1981 x 1981	1034	1095	910	971						
7'0"	1981 x 2134	1034	1095	910	971						
6'10" x 6'4"	2083 x 1930	1030	1091	929	990						
6'6"	2083 x 1981	1030	1091	952	1013						
7'0"	2083 x 2134	1056	1117	987	1048						
7'0" x 6'4"	2134 x 1930	1036 <sup>1</sup>	1097 <sup>1</sup>	941	1002					1717	1778
6'6"	<b>2134 x 1981</b>	<b>1006<sup>1</sup></b>	<b>1067<sup>1</sup></b>	<b>910<sup>1</sup></b>	<b>971<sup>1</sup></b>	<b>1273</b>	<b>1334</b>	<b>1273</b>	<b>1334</b>	<b>1717</b>	<b>1778</b>
7'0"	<b>2134 x 2134</b>	<b>1041<sup>1</sup></b>	<b>1102<sup>1</sup></b>	<b>953<sup>1</sup></b>	<b>1014<sup>1</sup></b>	<b>1343</b>	<b>1404</b>	<b>1343</b>	<b>1404</b>	<b>1734</b>	<b>1795</b>
7'6"	2134 x 2286		1273		1187						
7'3" x 6'4"	2210 x 1930	1089 <sup>1</sup>	1150 <sup>1</sup>	1023	1084						
6'6"	2210 x 1981	1093	1154	1027	1088						
7'0"	2210 x 2134	1106	1167	1038	1099						
7'5" x 6'6"	2261 x 1981	1100	1161	1023	1084					1781	1842
7'0"	2261 x 2134	1234	1295	1162	1223					1802	1863
7'6" x 6'4"	2286 x 1930	1124	1185	1023	1084					1781	1842
6'6"	2286 x 1981	1124 <sup>1</sup>	1185 <sup>1</sup>	1023 <sup>1</sup>	1084 <sup>1</sup>	1410	1471	1410	1471	1781	1842
7'0"	2286 x 2134	1234 <sup>1</sup>	1295 <sup>1</sup>	1166	1227	1624	1685	1624	1685	1802	1863
7'6"	2286 x 2286		1384		1419						
7'8" x 6'4"	2337 x 1930	1272	1333	1175	1236						
8'0" x 6'4"	2438 x 1930	1327	1388	1176	1237					1888	1949
6'6"	2438 x 1981	1327 <sup>1</sup>	1388 <sup>1</sup>	1176	1237	1665	1726	1665	1726	1888	1949
7'0"	2438 x 2134	1374 <sup>1</sup>	1435 <sup>1</sup>	1200	1261	1734	1795	1734	1795	1908	1969
7'6"	2438 x 2286		1557		1385						
8'0"	2438 x 2438		1611		1440						
8'6" x 6'6"	2590 x 1981		1496		1333						
7'0"	2590 x 2134		1624		1380						
9'0" x 6'6"	2743 x 1981		1728		1659						
7'0"	2743 x 2134		1888		1739						
10'0" x 6'6"	3048 x 1981		2094		2078						
7'0"	3048 x 2134		2094		2078						
<b>Prices Marked <sup>1</sup> – optional Terra brown RAL 8028 available. Surcharge on door, see page 9.</b>											
DOUBLE DOORS Internal frame sizes BR		2001 Vertical		2002 Horizontal		2601 Elegance		2602 Finesse		2101 Ilkley	
Imperial	Metric	Retractable		Retractable		Retractable		Retractable		Retractable	
11'0" x 6'6"	3353 x 1981	2276 *		2276 *							
7'0"	3353 x 2134	2293 *		2293 *							
12'0" x 6'6"	3658 x 1981	2390 *		2390 *							
7'0"	3658 x 2134	2408 *		2408 *							
13'0" x 6'6"	3962 x 1981	2600 *		2600 *							
7'0"	3962 x 2134	2619 *		2619 *							
14'0" x 6'6"	4267 x 1981	2505		2505						3467	
7'0"	4267 x 2134	2505		2505						3467	
<b>Prices Marked * – Not available ex-stock, delivery 4–5 weeks</b>											
MATCHING SIDE DOORS Ordering sizes		2001 Vertical		2002 Horizontal		2601 Elegance		2602 Finesse		Style Not Available	
Prices Marked <sup>2</sup> – Not available ex-stock, delivery 4–8 weeks											
875 x 1875		711		1506 <sup>2</sup>		1406 <sup>2</sup>		1406 <sup>2</sup>			
875 x 2000		711		1506 <sup>2</sup>		1406 <sup>2</sup>		1406 <sup>2</sup>			
875 x 2125		711 <sup>2</sup>		1506 <sup>2</sup>		1406 <sup>2</sup>		1406 <sup>2</sup>			
1000 x 2000		753 <sup>2</sup>		1553 <sup>2</sup>		1607 <sup>2</sup>		1607 <sup>2</sup>			
1000 x 2125		753		1553 <sup>2</sup>		1607 <sup>2</sup>		1607 <sup>2</sup>			



2103 Caxton		2004 Georgian		2304 Georgian with windows		2104 Marquess		2504 Countess		75mm steel framed doors Recommended structural opening sizes allowing tolerance of 10mm on width & 5mm on height For steel frame options see page 9	
CAN.	RET.	CAN.	RET.	CAN.	RET.	CAN.	RET.	CAN.	RET.	Imperial	Metric
		1254	1315							7'0" x 6'8½"	2135 x 2044
		1275	1336							7'0" x 7'2¾"	2135 x 2199
		1272	1333							7'4" x 6'6½"	2235 x 1994
		1273	1334							7'4" x 6'8½"	2235 x 2044
		1365	1426							7'4" x 7'2¾"	2235 x 2199
		1273	1334							7'6" x 6'6½"	2284 x 1994
1656	1717	1273 <sup>1</sup>	1334 <sup>1</sup>	1738	1799	1273	1334	1273	1334	7'6" x 6'8½"	2284 x 2044
1665	1726	1343 <sup>1</sup>	1404 <sup>1</sup>	1813	1874	1343	1404	1343	1404	7'6" x 7'2¾"	2284 x 2199
										7'6" x 7'8½"	2284 x 2350
		1410	1471							7'9¼" x 6'6½"	2365 x 1994
										7'9¼" x 6'8½"	2365 x 2044
										7'9¼" x 7'2¾"	2365 x 2199
		1410	1471							7'11" x 6'8½"	2411 x 2044
		1624	1685							7'11" x 7'2¾"	2411 x 2199
		1410	1471							8'0" x 6'6½"	2436 x 1994
		1410 <sup>1</sup>	1471 <sup>1</sup>	1880	1941	1410	1471			8'0" x 6'8½"	2436 x 2044
1769	1830	1624 <sup>1</sup>	1685 <sup>1</sup>	2092	2153	1624	1685			8'0" x 7'2¾"	2436 x 2199
										8'0" x 7'8½"	2436 x 2350
		1689	1750							8'2" x 6'6½"	2489 x 1994
		1665	1726							8'6" x 6'6½"	2589 x 1994
		1665	1726			1665	1726			8'6" x 6'8½"	2589 x 2044
		1734	1795			1734	1795			8'6" x 7'2¾"	2589 x 2199
										8'6" x 7'8½"	2589 x 2350
										8'6" x 8'2¾"	2589 x 2503
										9'0" x 6'8½"	2741 x 2044
										9'0" x 7'2¾"	2741 x 2199
			2180							9'6" x 6'8½"	2894 x 2044
			2218							9'6" x 7'2¾"	2894 x 2199
										10'6" x 6'8½"	3199 x 2044
										10'6" x 7'2¾"	3199 x 2199
<b>Style Not Available</b>		<b>2004 Georgian</b>		<b>2304 Georgian with windows</b>		<b>2104 Marquess</b>		<b>Style Not Available</b>			
		Retractable		Retractable		Retractable				Imperial	Metric
										11'6" x 6'8½"	3504 x 2044
										11'6" x 7'2¾"	3504 x 2199
										12'6" x 6'8½"	3809 x 2044
										12'6" x 7'2¾"	3809 x 2199
										13'6" x 6'8½"	4114 x 2044
										13'6" x 7'2¾"	4114 x 2199
		2697		3402 *		2697 *				14'6" x 6'8½"	4419 x 2044
		2697		3402 *		2697 *				14'6" x 7'2¾"	4419 x 2199
<b>Style Not Available</b>		<b>2004 Georgian</b>		<b>2304 Georgian with windows</b>		<b>2104 Marquess</b>		<b>Style Not Available</b>			
		1406 <sup>2</sup>		1654 <sup>2</sup>		1406 <sup>2</sup>					
		1406 <sup>2</sup>		1654 <sup>2</sup>		1406 <sup>2</sup>					
		1406 <sup>2</sup>		1654 <sup>2</sup>		1406 <sup>2</sup>					
		1607 <sup>2</sup>		1855 <sup>2</sup>		1607 <sup>2</sup>					
		1607 <sup>2</sup>		1855 <sup>2</sup>		1607 <sup>2</sup>					

# Hörmann Up-and-Over Doors

## Canopy & retractable with steel infill

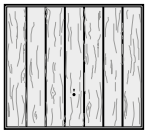
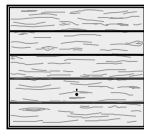
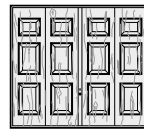
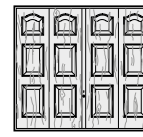
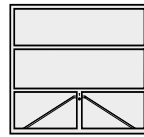

SINGLE DOORS											
Door sizes BR		Vertical Decograin Golden Oak or Rosewood		Horizontal Decograin Golden Oak or Rosewood		Georgian Decograin Golden Oak or Rosewood		Marquess Decograin Golden Oak or Rosewood		2011 Open for infill	
Imperial	Metric	CAN.	RET.	CAN.	RET.	CAN.	RET.	CAN.	RET.	CAN.	RET.
6'6" x 6'6"	1981 x 1981									878	939
7'0"	1981 x 2134									878	939
6'10" x 6'4"	2083 x 1930									878	939
6'6"	2083 x 1981										
7'0"	2083 x 2134										
7'0" x 6'4"	2134 x 1930									878	939
6'6"	<b>2134 x 1981</b>	<b>1292</b>	<b>1353</b>	<b>1151</b>	<b>1212</b>	<b>1520</b>	<b>1581</b>	<b>1520</b>	<b>1581</b>	878	939
7'0"	<b>2134 x 2134</b>	<b>1327</b>	<b>1388</b>	<b>1242</b>	<b>1303</b>	<b>1595</b>	<b>1656</b>	<b>1595</b>	<b>1656</b>	929	990
7'6"	2134 x 2286										
7'3" x 6'4"	2210 x 1930									971	1032
6'6"	2210 x 1981										
7'0"	2210 x 2134										
7'5" x 6'6"	2261 x 1981									971	1032
7'0"	2261 x 2134									1002	1063
7'6" x 6'4"	2286 x 1930									971	1032
6'6"	2286 x 1981	1375	1436	1273	1334			1689 <sup>4</sup>	1750 <sup>4</sup>	971	1032
7'0"	2286 x 2134	1482	1543	1416	1477	1947 <sup>4</sup>	2008 <sup>4</sup>	1947	2008	1001	1062
7'6"	2286 x 2286										
7'8" x 6'4"	2337 x 1930									1018	1079
8'0" x 6'4"	2438 x 1930									1018	1079
6'6"	2438 x 1981	1582	1643	1403	1464	1980	2041			1018	1079
7'0"	2438 x 2134	1628	1689	1452	1513	2049 <sup>3</sup>	2110 <sup>3</sup>	2049 <sup>3</sup>	2110 <sup>3</sup>	1018	1079
7'6"	2438 x 2286										
8'0"	2438 x 2438										
8'6" x 6'6"	2590 x 1981										
7'0"	2590 x 2134										
9'0" x 6'6"	2743 x 1981										1186
7'0"	2743 x 2134										1205
10'0" x 6'6"	3048 x 1981										1464
7'0"	3048 x 2134										1464
<b>Prices Marked <sup>3</sup> – Only available in Rosewood. Prices Marked <sup>4</sup> – only available in Golden oak</b>											
DOUBLE DOORS Internal frame sizes BR		Style Not Available		Style Not Available		Style Not Available		Style Not Available		2011 Open for infill	
Imperial	Metric									Retractable	
11'0" x 6'6"	3353 x 1981										2882
7'0"	3353 x 2134										3011
12'0" x 6'6"	3658 x 1981										3053
7'0"	3658 x 2134										3164
13'0" x 6'6"	3962 x 1981										3202
7'0"	3962 x 2134										3308
14'0" x 6'6"	4267 x 1981										2992
7'0"	4267 x 2134										2992
<b>Prices Marked * – Not available ex-stock, delivery 4 – 5 weeks</b>											
MATCHING SIDE DOORS Ordering sizes		2001 Golden Oak or Rosewood		2002 Golden Oak or Rosewood		2004 Golden Oak or Rosewood		2104 Golden Oak or Rosewood		2011 Open for infill	
<b>Prices Marked <sup>2</sup> – Not available ex-stock, delivery 4 – 8 weeks</b>											
875 x 1875		1564 <sup>2</sup>		1564 <sup>2</sup>		1564 <sup>2</sup>		1564 <sup>2</sup>		711	
875 x 2000		1575 <sup>2</sup>		1575 <sup>2</sup>		1575 <sup>2</sup>		1575 <sup>2</sup>		711	
875 x 2125		1585 <sup>2</sup>		1585 <sup>2</sup>		1585 <sup>2</sup>		1585 <sup>2</sup>		711	
1000 x 2000		1800 <sup>2</sup>		1800 <sup>2</sup>		1800 <sup>2</sup>		1800 <sup>2</sup>		753	
1000 x 2125		1809 <sup>2</sup>		1809 <sup>2</sup>		1809 <sup>2</sup>		1809 <sup>2</sup>		753	



The door leaf and optional box section steel frame are made of galvanised material that is polyester powder coated on both sides.

This finish is extremely durable and the standard colour is Traffic white RAL 9016.

Other colours are available listed in optional extras below.

To help maintain the aesthetic appearance of your door and prevent the build up of dirt, salt and other corrosive substances the door should be washed with a mild soap-based solution on a regular basis.

If the door is located near the coast it is important that the door panel and frame should be washed at least every 2 months.

We also suggest that all other components are brushed down on a regular basis to prevent the build up of dirt and dust etc.

The window frames on the Georgian and Ilkley doors are UPVC and white as standard.

These frames are a 2-part construction with the window material sandwiched between and frames screwed together from the back for security.

The finish of the Decograin doors is a synthetic foil-coated timber design outside (inside primer white).

The leaf frame and fixing frame is a matching powder coating.

Optional extras for Steel Doors	Price
<b>75mm</b> Steel fixing frame for either canopy or retractable geared single doors. Factory fitted	<b>191</b>
<b>75mm</b> Steel fixing frame for either canopy or retractable geared single doors. Factory fitted with frame to compliment Decograin	<b>191</b>
<b>75mm</b> Steel fixing frame for <b>DOUBLE</b> retractable geared doors, when ordered with the door	<b>298</b>
<b>60mm</b> Steel fixing frame for canopy geared doors only. Factory fitted	<b>197</b>
<b>60mm</b> Steel fixing frame for canopy geared doors only. Factory fitted with frame to compliment Decograin	<b>197</b>
Prices marked <sup>1</sup> – optional Terra Brown RAL 8028 available. Surcharge on door	<b>58</b>
Retractable plus gear for retractable doors up to 7'6" wide giving extra drive through width	
Surcharge on retractable price. Retractable Plus is not available on some sizes and styles of OFI doors – if required, please check with our sales office prior to order acceptance	<b>101</b>
4 point locking kit for extra security, factory fit with door order or retrofit – single door sizes only	<b>91</b>
3 point locking kit for extra security, factory fit with door (this cannot be retrofitted). Available for 2001 side doors only	<b>160</b>
Window options for 2304 Georgian style door – Plain, crossed or diamond style with crystal glazing	<b>Incl.</b>

**Colours are available to special order in the following styles:**

2001 Vertical, 2002 Horizontal, 2101 Ilkley available in all the listed sizes

2004 Georgian, 2304 Georgian with windows and 2104 Marquess are available in 7066, 7070, 7566, 7570, 7666, 7670 and 8066, 8070 sizes only (where shown)

2601 Elegance and 2602 Finesse are available in white & Anthracite Grey only

**Please note:** Caxton and Countess steel up-and-over doors are only available in white

**Colours** Terra brown RAL 8028, Signal blue RAL 5005, Steel blue RAL 5011, Moss green RAL 6005, Ruby red RAL 3003, Jet black RAL 9005 & Anthracite grey RAL 7016

Includes matching frame if ordered with door. White frame RAL 9016 also available, please specify when ordering

Please allow 5-6 weeks lead time for coloured doors

<b>For an increased range of RAL-to-choose colours in our Series 2000 range of up-and-over garage doors, please ask your Hörmann dealer.</b>	Single doors	<b>181</b>
	Double doors	<b>288</b>

**Please consult your Hörmann dealer for steel garage door styles that are available from STOCK in colours: Anthracite grey RAL 7016, Jet black RAL 9005, Moss green RAL 6005, Ruby red RAL 3003 and Steel blue RAL 5011**

**Coloured window frames for Georgian and Ilkley doors:**

Coloured window frames to match door colour

Georgian doors (price per window, see note below for the number of windows) **60**

Ilkley doors (price per single door) **256**

Ilkley doors (price per double door) **499**

Please state coloured windows required on order

Orders received without reference will be supplied with white as standard

Georgian doors up to 10' wide = 4 windows, 11' to 13' = 6 windows, 14' = 8 windows

**Please note:** Doors with windows may have cross bracing or locking rods passing behind the windows depending upon size and gear type.

Optional handle sets	
Cast aluminium white	<b>268</b>
Brushed or polished stainless steel	<b>324</b>
Matching lever handles are also available for side doors	<b>P.O.A.</b>

## Product description

Applies to all registered LPU 42/67 unmodified sectional garage doors, using a Hörmann operator and fitted behind the opening. To register your door, email us at [info@hormann.co.uk](mailto:info@hormann.co.uk).

### Views

(The illustrations correspond to size 2500 × 2125 mm. Deviations may occur with other sizes.)

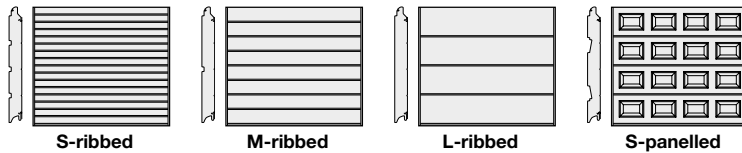

### General information

Sectional garage doors for private purposes. Prepared for Hörmann garage door operators, 10 door cycles per day in accordance with the warranty conditions.

### Door leaf

With finger trap protection on outside and inside.

Door sections made of double-skinned steel sections, depth 42 mm, made of hot-galvanized sheet steel, PU-foamed, Stucco-textured on interior.

- S-ribbed *Woodgrain*-embossed on exterior
- M-ribbed *Woodgrain*-embossed, *Slategrain*-embossed, *Plaingrain*, *Silkgrain* or *Decograin* on exterior
- L-ribbed *Woodgrain*-embossed, *Slategrain*-embossed, *Plaingrain*, *Silkgrain*, *Decograin* or *Duragrain* on exterior
- S-panelled *Woodgrain*-embossed on exterior

### Thermal insulation value:

- Section 42 mm  $U = 0.5 \text{ W}/(\text{m}^2\cdot\text{K})$
  - Fitted door 42 mm (without ThermoFrame) \*  $U = 1.3 \text{ W}/(\text{m}^2\cdot\text{K})$
  - Fitted door 42 mm (with ThermoFrame) \*  $U = 1.2 \text{ W}/(\text{m}^2\cdot\text{K})$
- \* Without glazing, door size 5000 × 2250 mm

### Versions:

Any door height divided in even door sections (except intermediate heights).

- S-ribbed or M-ribbed: horizontal increments evenly spaced in height
- L-ribbed
- S-panelled: Panel arrangement evenly spaced in width

Bottom door section with bottom seal as standard.

### Notice on door leaf reinforcement:

Sun exposure may result in deflection of the door elements and foam break. To reduce the possibility of section deflection caused by sun exposure, all doors from LZ > 5000 mm are equipped at the factory with the door leaf reinforcement set.

The following colours and decors are equipped at the factory with the door leaf reinforcement set from LZ > 4500 mm.

- RAL colours
 

RAL 3007 Black red	RAL 6022 Olive drab
RAL 4007 Purple violet	RAL 7016 Anthracite grey
RAL 5003 Sapphire blue	RAL 7021 Black grey
RAL 5004 Black blue	RAL 7043 Traffic grey
RAL 5011 Steel blue	RAL 8014 Sepia brown
RAL 5013 Cobalt blue	RAL 8016 Mahogany brown
RAL 5020 Ocean blue	RAL 8017 Chocolate brown
RAL 5022 Night blue	RAL 8019 Grey brown
RAL 6004 Blue green	RAL 8022 Black brown
RAL 6005 Moss green	RAL 8028 Terra brown
RAL 6007 Bottle green	RAL 9004 Signal black
RAL 6008 Brown green	RAL 9005 Jet black
RAL 6009 Fir green	RAL 9011 Graphite black
RAL 6012 Black green	RAL 9017 Traffic black
RAL 6015 Black olive	
- Colour CH 703
- Noir 2100 Sablé (Anthracite Metallic)
- Colour CH 907 matched to Internorm windows and doors in RAL 9007
- Slategrain and Plaingrain Color RAL 7016 Anthracite grey (matt-textured) and CH 703 Anthracite metallic (matt-textured)
- Decograin decors Dark Oak, Night Oak, Rosewood and Titan Metallic CH 703
- Duragrain decors Sapeli, Terra Walnut Terra, Moca, Grigio scuro, Rusty Steel, Rusty Patina, Burned Oak, Cherry, Rusty Oak, Noce sorrento balsamico, Corten Steel, Toffee Oak

Colours and decors that have not been listed may be ordered with the optional door leaf reinforcement set as optional equipment.

In case of any doubt, we recommend ordering door leaf reinforcement optionally for doors under thermal load not equipped with door leaf reinforcement at the factory.

Door leaf reinforcement limits section deflection, but does not prevent it completely.

The use of a SupraMatic is recommended for doors with operator and door leaf reinforcement see door operators section in 01-26 A.



## Product description

### Frame

- **Door frame**  
with trap guard, made of hot-galvanized sheet steel, *Woodgrain*-embossed, with side seal and plastic frame shoe.  
Standard version: Frame with high-quality coating in Traffic white, based on RAL 9016; galvanized tracks, suspensions and connection rail.  
Premium version: Frame, tracks, suspensions and connection rail with high-quality coating in Grey white based on RAL 9002.
  - **Fascia panel, single-skinned, with seal to make up for insufficient headroom up to 100 mm**
    - In *Woodgrain*-embossed with Woodgrain doors.
    - In smooth for *Slategrain*-embossed, *Plaingrain*, *Silkgrain* and *Decograin*. Fascia panel in door colour for doors with RAL 9016, Color, Color matt-textured, RAL to choose and Noir 2100 Sablé.
    - In *Decograin* (with high-quality plastic film coating, for possible decors).
    - In *Duragrain* as standard with high-quality decor and high-quality protective paint.
  - **Frame covering, single-skinned** (optional for a surcharge) required for fitting in the reveal in the versions:
    - In *Woodgrain*-embossed, *Silkgrain* or *Decograin*
    - In smooth for *Slategrain*-embossed, *Plaingrain* or *Duragrain*
- For possible surface coating (colours / decors), see product description. Please state desired colour / decor on order!

### Counterbalance

- Tension spring technology:  
with lateral integral double tension springs with 2 cables on each side
    - up to door width 3250 mm and door height 2600 mm,
    - up to door width 3500 mm and door height 2375 mm,
    - up to door width 4000 mm and door height 2250 mm
  - Torsion spring assembly:  
Torsion spring assembly with cable drums and approved spring safety device as well as integral lateral cables
    - from door width 3251 mm and door height 2600 mm,
    - from door width 3501 mm and door height 2375 mm,
    - from door width 4001 mm and door height 2250 mm
- Tension springs and torsion springs are galvanized.

### Fittings and closing devices

As standard without door handle set and lock. The door handle sets to be ordered separately are supplied including a template for an on-site lock knock-out. A factory lock knock-out will result in a longer delivery time and must be ordered explicitly.  
If a sectional door without door handle set and lock is equipped with an operator, an emergency release is required if there is no second entrance!

### Fitting parts

As standard, the fitting parts are galvanized.

### Premium version

The following components are supplied in RAL 9002:

- Door leaf fittings
- Side frames
- Horizontal tracks incl. connection rail and double radius
- Defined accessory parts

### PremiumPlus version

Components are supplied as Premium version in RAL 9002, additional:

- Double door leaf painted in colour with high-quality protective paint (clear varnish)
- Cut edge sealing
- Painted end cap
- Ribbing infill profile

### Recommendations:

- Adjustable bottom profile set must be used.  
Note the surcharge!
- Not possible for *Slategrain* and *Plaingrain*.

### Version with break-in-resistant fitting RC 2

Break-in-resistant sectional garage door LPU 42 according to DIN/TS 18194 RC2 with and without wicket door.

- Only for doors with operator!
- Fitting behind the reveal only!
- For track applications Z, N and L only!
- 2. Entrance to the garage required!
- Premium version possible.



## Product description

Applies to all registered LPU 42/67 unmodified sectional garage doors, using a Hörmann operator and fitted behind the opening. To register your door, email us at [info@hormann.co.uk](mailto:info@hormann.co.uk).

### Surface coating of door leaf

#### Woodgrain and Silkgrain version with double-sided coating

##### Interior:

- Primer coating in standard colour, Grey white, similar to RAL 9002 (silk-gloss)

##### With high-quality coating on the exterior:

- Traffic white as standard based on RAL 9016 (silk-gloss)
- Color, preferred colours based on the RAL CLASSIC colour chart
 

RAL 1015	Light ivory (silk-gloss)		
RAL 6005	Moss green (silk-gloss)		
RAL 6009	Fir green (silk-gloss)		
RAL 9006	White aluminium (silk-matt)		
RAL 9007	Grey aluminium (silk-matt)		
- MatchColor, preferred colours based on the RAL CLASSIC colour chart (silk-gloss)
 

RAL 7012	Basalt grey	RAL 7039	Quartz grey
RAL 7015	Slate grey	RAL 7040	Window grey
RAL 7016	Anthracite grey	RAL 8028	Terra brown
RAL 7030	Stone grey	RAL 9005	Jet black
RAL 7035	Light grey		
- Hörmann colour CH 703 Anthracite metallic (silk-matt) similar to CH 703 for LPU 67 and industrial sectional doors
- Noir 2100 Sablé
- RAL of choice\*, based on the RAL CLASSIC colour chart
- Colour CH 907, matched to Internorm windows and doors in RAL 9007 (HM907)
- Colour DB 703 for LPU 42 / LPU 67 sectional garage doors and industrial sectional doors
- Colour 8077 matched to Schüco windows and doors in brown
- Special colours on request (other colour systems, such as NCS or DB \* colours)

Not available are RAL 9021 as well as pearl-effect colours and fluorescent colours.

\* In wicket door version in Silkgrain, the following colours are not available: RAL: 3007, 5004, 7021, 8022, 9004, 9011, 9017

#### Slategrain and Plaingrain version with double-sided coating

##### Slategrain

with textured slate structure on the exterior, interior Stucco-textured

##### Plaingrain

with smooth surface finish on the exterior, interior Stucco-textured

##### Interior:

- Primer coating in standard colour, Grey white, similar to RAL 9002 (silk-gloss) (no additional interior coating possible)

##### With high-quality coating on the exterior:

- Traffic white (matt-textured) as standard based on RAL 9016
- Color matt-textured based on the RAL CLASSIC colour chart
 

RAL 7016	Anthracite grey
RAL 9006	White aluminium
RAL 9007	Grey aluminium
- Hörmann colour CH 703 Anthracite metallic

Other colours and RAL of choice are not possible!

#### Version with high-quality protective paint (silk-matt clear varnish) on the exterior for side doors with Woodgrain and Silkgrain surface finish

##### Protective paint:

- Increase in weather protection and prevention of chalking.
- No increase in corrosion protection in the area of cut edges.

##### Protective paint "Anti-Graffiti"

- Simple removal of graffiti by using GraffitiX from the manufacturer Matecra. Available from specialised retailers.
- Increase in weather protection and prevention of chalking.
- No increase in corrosion protection in the area of cut edges.

##### Recommendations:

The protective paint gives the coated surface a more matt appearance. A direct combination between coated products and products with additional high-strength protective paint should be avoided due to the different gloss levels!

High-strength protective paint is not possible for the surface finishes Slategrain, Plaingrain and Decograin.

#### Notes on coating

Dark colours should not be used for double-skinned steel doors that are exposed to the sun, as possible section deflection may restrict the door's function. In case of any doubt, we recommend choosing the optional door leaf reinforcements for wider doors exposed to the sun that are not reinforced as standard.

Deviations in colour are to be expected due to the use of different base materials, such as aluminium and steel, and textures, as well as due to varying production processes and locations and differences between standard products and campaign products. Despite the use of state-of-the-art colour coating systems, colour deviations cannot be ruled out, specifically in RAL 9005 and Noir 2100 Sablé, as well as metallic colours such as RAL 9006 and RAL 9007.

##### MatchColor:

These colours offer a high degree of colour fidelity for products from different Hörmann factories. Visual colour variations between the aluminium entrance doors, entrance doors made of steel and sectional garage doors with smooth surface are largely excluded.

If a high-quality protective paint is selected, the gloss level changes and the MatchColor effect is no longer guaranteed.

##### Note:

The visual quality can vary within one surface coating.



## Product description

Applies to all registered LPU 42/67 unmodified sectional garage doors, using a Hörmann operator and fitted behind the opening. To register your door, email us at [info@hormann.co.uk](mailto:info@hormann.co.uk).

### Surface coating of door leaf

#### Duragrain version with high-quality decor print and high-quality protective paint (matt clear varnish) on the exterior

##### Interior:

- Primer coating in standard colour, Grey white, similar to RAL 9002 (silk-gloss) (no additional interior coating possible)

##### With high-quality coating on the exterior:

- Duragrain decors with high-quality protective paint (matt), authentic surface finish look.

Antique Parquet	Rosewood
Bamboo	Rusty Oak
Beige	Rusty Steel
Concrete	Sapele
Burned Oak	Screed
Cherry	Sheffield
Concrete Surface	Barnwood grey
Corten Steel	Teak
Spruce	Toffee Oak
Grigio	Used Look
Grigio scuro	Vintage Boards
Grunge Wall	Colonial Walnut
Limestone	Terra Walnut
Malt Oak	White brushed
Moca	White Oak
Nature Oak	Whiteoiled Oak
Night Oak	Whitewashed Oak
Noce sorrento balsamico	Winchester Oak
Noce sorrento nature	

- **Hörmann Designer / Individual print**

Wide selection of licensed images and decors in the product configurator. The size range depends on the image or decor.

The coating colour of the accessories (e.g. frame covering, single-skinned panels and glazing frames) is individually specified by the customer.

##### Recommendations:

- Factory inspection for technical feasibility (on request).
- Not possible for chamfered adjustment and PU panels of all kinds.

- **Duragrain decors with a matching look**

matching ThermoSafe aluminium entrance doors with MatchDecor surface finishes

Rusty Patina  
 Barnwood  
 Wild Oak  
 Cement

- **Vertical design**

Selected Duragrain decor with vertical ribbed look (125 mm)

Burned Oak	Sheffield
Spruce	Whiteoiled Oak
Malt Oak	Whitewashed Oak

**Note:** Not possible with fixed elements.

Printed accessories, such as single-skinned panel and frame covering, possible.

The colour of the accessories (e.g. frame covering, single-skinned panels, panel brackets of fixed elements and glazing frames) can be optionally specified by the customer.

#### Decograin version with high-quality plastic film coating with timber design on exterior

##### Interior:

- Primer coating in standard colour, grey white, similar to RAL 9002 (silk-gloss) (no additional interior coating possible)

##### Exterior:

- Coated with a timber design plastic film (matt) with embossed timber structure for an authentic timber look.

**Golden Oak:** Medium-brown, golden yellow oak design

**Dark Oak:** Walnut-coloured oak design

- Coated with a plastic film (matt) in **Titan Metallic CH 703**

##### Colours matched to Decograin

The glazing frames are coated in a colour matching the decor.

#### Vario Design version with different section in the door leaf

##### Interior:

- Primer coating in standard colour, grey white, similar to RAL 9002 (silk-gloss) (no additional interior coating possible)

##### Exterior:

Different section in the door leaf, in Duragrain or Decograin

The basic door must be Woodgrain, Slategrain, Plaingrain or Silkgrain.

Max. number of different sections in dependence of the door height:

Door with 4 sections	1 different section
Door with 5 sections	2 different sections
Door with 6 sections	3 different sections

Only possible up to LZ 5500 mm!

Not possible for doors with wicket doors!

The colour of the accessories (e.g. frame covering, single-skinned panels, panel brackets of fixed elements and glazing frames) can be optionally specified by the customer.

# Hörmann Sectional Doors

LPU 42 – double-skinned doors with steel sections – 42mm

Single doors with Z track tension springs giving low headroom as standard

Secured by Design



Police Preferred Specification

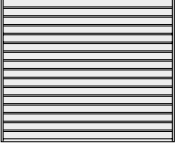
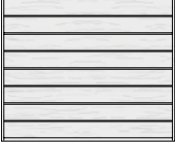
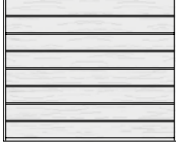
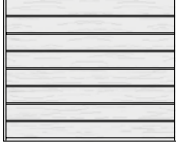

SINGLE DOORS											
Door sizes BR		Outside White	Outside Colour*	Outside White	Outside Colour*	Outside White	Outside Colour*	Outside White	Outside Colour*	Outside White	Outside Colour*
Imperial	Metric										
6'10" x 6'6"	2080 x 2000	1490	1748	1490	1748	1490	1748	1490	1748	1490	1748
	2080 x 2080	1547	1816	1547	1816	1547	1816	1547	1816	1547	1816
7'0" x 6'6"	2134 x 2000	1544	1809	1544	1809	1544	1809	1544	1809	1544	1809
	2134 x 2125	1597	1879	1597	1879	1597	1879	1597	1879	1597	1879
7'6" x 6'6"	2286 x 2000	1544	1828	1544	1828	1544	1828	1544	1828	1544	1828
	2286 x 2125	1597	1899	1597	1899	1597	1899	1597	1899	1597	1899
	2286 x 2250	1616	1935	1616	1935	1616	1935	1616	1935	1616	1935
	2286 x 2375	1745	2082	1745	2082	1745	2082	1745	2082	1745	2082
8'0" x 6'6"	2438 x 2000	1624	1927	1624	1927	1624	1927	1624	1927	1624	1927
	2438 x 2125	1687	2009	1687	2009	1687	2009	1687	2009	1687	2009
	2438 x 2250	1671	2012	1671	2012	1671	2012	1671	2012	1671	2012
	2438 x 2375	1766	2125	1766	2125	1766	2125	1766	2125	1766	2125
8'6" x 6'6"	2591 x 2000	1624	1946	1624	1946	1624	1946	1624	1946	1624	1946
	2591 x 2125	1687	2029	1687	2029	1687	2029	1687	2029	1687	2029
	2740 x 2000	1758	2098	1758	2098	1758	2098	1758	2098	1758	2098
	2740 x 2125	1819	2180	1819	2180	1819	2180	1819	2180	1819	2180
9'0" x 6'6"	2896 x 2000	1837	2197	1837	2197	1837	2197	1837	2197	1837	2197
	2896 x 2125	1913	2295	1913	2295	1913	2295	1913	2295	1913	2295
10'0" x 6'6"	3048 x 2000	1776	2154	1776	2154	1776	2154	1776	2154	1776	2154
	3048 x 2125	1840	2242	1840	2242	1840	2242	1840	2242	1840	2242

\*For information on exterior colour, see page 13.

Double doors with N track springs (see shaded area of grid). For low headroom see bottom of page 17

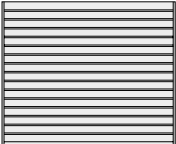
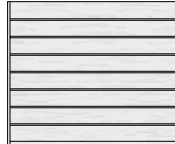
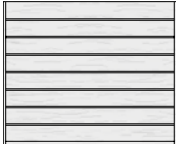
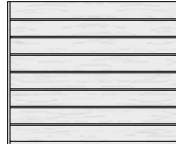
DOUBLE DOORS											
Door sizes BR		Outside White	Outside Colour*	Outside White	Outside Colour*	Outside White	Outside Colour*	Outside White	Outside Colour*	Outside White	Outside Colour*
Imperial	Metric										
11'0" x 6'6"	3353 x 2000	2095	2511	2095	2511	2095	2511	2095	2511	2095	2511
	3353 x 2125	2180	2622	2180	2622	2180	2622	2180	2622	2180	2622
12'0" x 6'6"	3658 x 2000	2398	2852	2398	2852	2398	2852	2398	2852	2398	2852
	3658 x 2125	2468	2950	2468	2950	2468	2950	2468	2950	2468	2950
13'0" x 6'6"	3962 x 2000	2527	3019	2527	3019	2527	3019	2527	3019	2527	3019
	3962 x 2125	2603	3125	2603	3125	2603	3125	2603	3125	2603	3125
14'0" x 6'6"	4267 x 2000	2650	3180	2650	3180	2650	3180	2650	3180	2650	3180
	4267 x 2125	2757	3320	2757	3320	2757	3320	2757	3320	2757	3320
14'6" x 6'6"	4420 x 2000	2739	3288	2739	3288	2739	3288	2739	3288	2739	3288
	4420 x 2125	2850	3433	2850	3433	2850	3433	2850	3433	2850	3433
15'0" x 6'6"	4572 x 2000	2790	3357	2790	3357	2790	3357	2790	3357	2790	3357
	4572 x 2125	2899	3502	2899	3502	2899	3502	2899	3502	2899	3502
15'6" x 6'6"	4725 x 2000	2892	3478	2892	3478	2892	3478	2892	3478	2892	3478
	4725 x 2125	2975	3598	2975	3598	2975	3598	2975	3598	2975	3598
16'0" x 6'6"	4877 x 2000	2909	3514	2909	3514	2909	3514	2909	3514	2909	3514
	4877 x 2125	3023	3666	3023	3666	3023	3666	3023	3666	3023	3666

Intermediate sizes are available, please see your dealer for more details

# Hörmann Sectional Doors

LPU 42 – double-skinned doors with steel sections – 42mm

Single doors with Z track tension springs giving low headroom as standard

Secured by Design



Police Preferred Specification

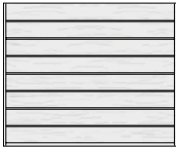
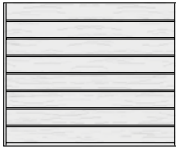
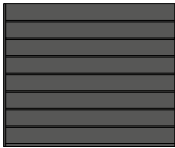

SINGLE DOORS							
Door sizes BR		M-ribbed Silkgrain		M-ribbed Decograin		M-ribbed Titan Metallic CH 703	
Imperial	Metric	Outside White	Outside Colour*	Outside Timber Design*		Outside Titan Metallic CH 703*	
6'10" x 6'6"	2080 x 2000	1834	2092	2018		2018	
6'10"	2080 x 2080	1905	2174	2096		2096	
7'0" x 6'6"	2134 x 2000	1834	2099	2018		2018	
7'0"	2134 x 2125	1905	2187	2096		2096	
7'6" x 6'6"	2286 x 2000	1834	2118	2018		2018	
7'0"	2286 x 2125	1905	2207	2096		2096	
7'4"	2286 x 2250	1992	2311	2193		2193	
7'9"	2286 x 2375	2080	2417	2290		2290	
8'2"	2286 x 2500	2163	2518	2382		2382	
8'0" x 6'6"	2438 x 2000	1942	2245	2140		2140	
7'0"	2438 x 2125	2025	2347	2232		2232	
7'4"	2438 x 2250	2082	2423	2295		2295	
7'9"	2438 x 2375	2182	2541	2406		2406	
8'2"	2438 x 2500	2215	2593	2441		2441	
8'6" x 6'6"	2591 x 2000	1942	2264	2140		2140	
7'0"	2591 x 2125	2025	2367	2232		2232	
9'0" x 6'6"	2740 x 2000	2129	2469	2351		2351	
7'0"	2740 x 2125	2212	2573	2444		2444	
9'6" x 6'6"	2896 x 2000	2242	2602	2480		2480	
7'0"	2896 x 2125	2330	2712	2578		2578	
10'0" x 6'6"	3048 x 2000	2242	2620	2480		2480	
7'0"	3048 x 2125	2330	2732	2578		2578	

\*For information on exterior colour, see page 13.

**Double doors with N track springs (see shaded area of grid). For low headroom see bottom of page 17**

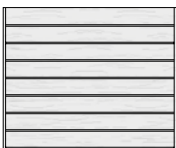
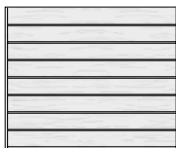
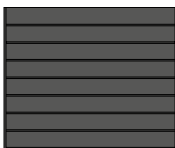
DOUBLE DOORS							
Door sizes BR		M-ribbed Silkgrain		M-ribbed Decograin		M-ribbed Titan Metallic CH 703	
Imperial	Metric	Outside White	Outside Colour*	Outside Timber Design*		Outside Titan Metallic CH 703*	
11'0" x 6'6"	3353 x 2000	2682	3098	2979		2979	
7'0"	3353 x 2125	2789	3231	3098		3098	
12'0" x 6'6"	3658 x 2000	2974	3428	3309		3309	
7'0"	3658 x 2125	3068	3550	3414		3414	
13'0" x 6'6"	3962 x 2000	3118	3610	3472		3472	
7'0"	3962 x 2125	3207	3729	3571		3571	
14'0" x 6'6"	4267 x 2000	3210	3740	3577		3577	
7'0"	4267 x 2125	3341	3904	3723		3723	
14'6" x 6'6"	4420 x 2000	3293	3842	3671		3671	
7'0"	4420 x 2125	3427	4010	3820		3820	
15'0" x 6'6"	4572 x 2000	3318	3885	3699		3699	
7'0"	4572 x 2125	3460	4063	3857		3857	
15'6" x 6'6"	4725 x 2000	3384	3970	3773		3773	
7'0"	4725 x 2125	3513	4136	3918		3918	
16'0" x 6'6"	4877 x 2000	3442	4047	3840		3840	
7'0"	4877 x 2125	3580	4223	3993		3993	

Intermediate sizes are available, please see your dealer for more details

# Hörmann Sectional Doors

LPU 42 – double-skinned doors with steel sections – 42mm

Single doors with Z track tension springs giving low headroom as standard

Secured by Design



Police Preferred Specification

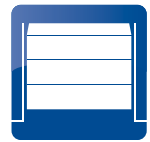

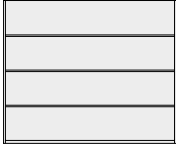
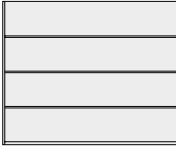
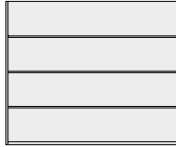
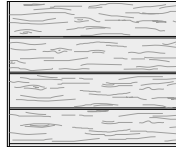
SINGLE DOORS								
Door sizes BR		L-ribbed Slategrain		L-ribbed Plaingrain		L-ribbed Silkgrain		L-ribbed Decograin
Imperial	Metric	Outside White	Outside Colour*	Outside White	Outside Colour*	Outside White	Outside Colour*	Outside Timber Design*
6'10" x 6'6"	2080 x 2000	1635	1893	1635	1893	2055	2313	2255
6'10" x 6'10"	2080 x 2080	1696	1965	1696	1965	2080	2349	2282
7'0" x 6'6"	2134 x 2000	1699	1964	1699	1964	2055	2320	2255
7'0" x 7'0"	2134 x 2125	1756	2038	1756	2038	2080	2362	2282
7'6" x 6'6"	2286 x 2000	1699	1983	1699	1983	2055	2339	2255
7'0" x 7'0"	2286 x 2125	1756	2058	1756	2058	2080	2382	2282
7'4" x 7'4"	2286 x 2250	1776	2095	1776	2095	2171	2490	2382
7'9" x 7'9"	2286 x 2375	1919	2256	1919	2256	2181	2518	2392
8'2" x 8'2"	2286 x 2500	1913	2268	1913	2268	2236	2591	2451
8'0" x 6'6"	2438 x 2000	1788	2091	1788	2091	2159	2462	2372
7'0" x 7'0"	2438 x 2125	1860	2182	1860	2182	2216	2538	2435
7'4" x 7'4"	2438 x 2250	1839	2180	1839	2180	2236	2577	2455
7'9" x 7'9"	2438 x 2375	1947	2306	1947	2306	2346	2705	2577
8'2" x 8'2"	2438 x 2500	1945	2323	1945	2323	2348	2726	2577
8'6" x 6'6"	2591 x 2000	1788	2110	1788	2110	2171	2493	2386
7'0" x 7'0"	2591 x 2125	1860	2202	1860	2202	2216	2558	2435
9'0" x 6'6"	2740 x 2000	1941	2281	1941	2281	2390	2730	2631
7'0" x 7'0"	2740 x 2125	2010	2371	2010	2371	2423	2784	2667
9'6" x 6'6"	2896 x 2000	2031	2391	2031	2391	2524	2884	2782
7'0" x 7'0"	2896 x 2125	2116	2498	2116	2498	2558	2940	2819
10'0" x 6'6"	3048 x 2000	1963	2341	1963	2341	2524	2902	2782
7'0" x 7'0"	3048 x 2125	2032	2434	2032	2434	2558	2960	2819

\*For information on exterior colour, see page 13.

**Double doors with N track springs (see shaded area of grid). For low headroom see bottom of page 17**

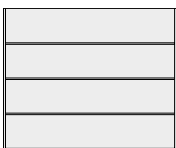
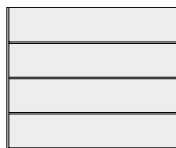
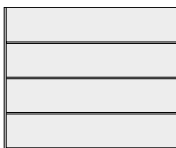
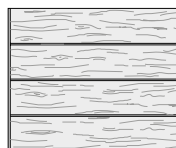
DOUBLE DOORS								
Door sizes BR		L-ribbed Slategrain		L-ribbed Plaingrain		L-ribbed Silkgrain		L-ribbed Decograin
Imperial	Metric	Outside White	Outside Colour*	Outside White	Outside Colour*	Outside White	Outside Colour*	Outside Timber Design*
11'0" x 6'6"	3353 x 2000	2325	2741	2325	2741	3001	3417	3319
7'0" x 7'0"	3353 x 2125	2419	2861	2419	2861	3046	3488	3368
12'0" x 6'6"	3658 x 2000	2673	3127	2673	3127	3160	3614	3498
7'0" x 7'0"	3658 x 2125	2747	3229	2747	3229	3184	3666	3523
13'0" x 6'6"	3962 x 2000	2820	3312	2820	3312	3401	3893	3769
7'0" x 7'0"	3962 x 2125	2902	3424	2902	3424	3491	4013	3869
14'0" x 6'6"	4267 x 2000	2959	3489	2959	3489	3609	4139	4003
7'0" x 7'0"	4267 x 2125	3078	3641	3078	3641	3670	4233	4070
14'6" x 6'6"	4420 x 2000	3060	3609	3060	3609	3674	4223	4076
7'0" x 7'0"	4420 x 2125	3183	3766	3183	3766	3766	4349	4178
15'0" x 6'6"	4572 x 2000	3115	3682	3115	3682	3749	4316	4160
7'0" x 7'0"	4572 x 2125	3241	3844	3241	3844	3809	4412	4226
15'6" x 6'6"	4725 x 2000	3232	3818	3232	3818	3819	4405	4239
7'0" x 7'0"	4725 x 2125	3330	3953	3330	3953	3886	4509	4312
16'0" x 6'6"	4877 x 2000	3253	3858	3253	3858	3887	4492	4316
7'0" x 7'0"	4877 x 2125	3380	4023	3380	4023	3957	4600	4392

Intermediate sizes are available, please see your dealer for more details

# Hörmann Sectional Doors

LPU 42 – double-skinned doors with steel sections – 42mm

Single doors with Z track tension springs giving low headroom as standard

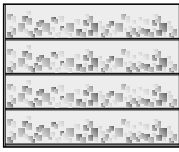
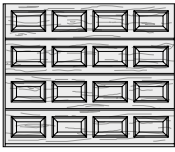

SINGLE DOORS		 <b>L-ribbed Titan Metallic CH703</b> Outside Titan Metallic CH703*	 <b>L-ribbed Duragrain</b> Outside Decor Coating*	 <b>S-panelled Woodgrain</b>		No. of panels
Door sizes BR				Outside White	Outside Colour*	
Imperial	Metric					
6'10" x 6'6"	2080 x 2000	2255	2255	1886	2144	4
6'10"	2080 x 2080	2282	2282	1908	2177	4
7'0" x 6'6"	2134 x 2000	2255	2255	1950	2215	4
7'0"	2134 x 2125	2282	2282	1978	2260	4
7'6" x 6'6"	2286 x 2000	2255	2255	1950	2234	4
7'0"	2286 x 2125	2282	2282	1978	2280	4
7'4"	2286 x 2250	2382	2382	1969	2288	4
7'9"	2286 x 2375	2392	2392	2104	2441	4
8'2"	2286 x 2500	2451	2451	2101	2456	4
8'0" x 6'6"	2438 x 2000	2372	2372	1994	2297	4
7'0"	2438 x 2125	2435	2435	2079	2401	4
7'4"	2438 x 2250	2455	2455	2077	2418	4
7'9"	2438 x 2375	2577	2577	2196	2555	4
8'2"	2438 x 2500	2577	2577	2198	2576	4
8'6" x 6'6"	2591 x 2000	2386	2386	2059	2381	4
7'0"	2591 x 2125	2435	2435	2091	2433	4
9'0" x 6'6"	2740 x 2000	2631	2631	2241	2581	4
7'0"	2740 x 2125	2667	2667	2274	2635	4
9'6" x 6'6"	2896 x 2000	2782	2782	2353	2713	5
7'0"	2896 x 2125	2819	2819	2399	2781	5
10'0" x 6'6"	3048 x 2000	2782	2782	2259	2637	5
7'0"	3048 x 2125	2819	2819	2305	2707	5

\* For information on outside colour, see below & page 13.

All coloured doors are special order only – 4 to 8 weeks delivery. Please note: the prices listed as Outside Colour are for the following colours only: RAL 1015, 6005, 6009, 7012, 7015, 7016, 7030, 7035, 7038, 7039, 7040, 8028, 9005, 9006 and 9007, CH703 Anthracite metallic & Chartwell green. Special RAL colours are available, please ask your garage door specialist.

**Double doors with N track springs (see shaded area of grid). For low headroom see bottom of page**

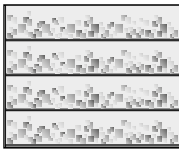
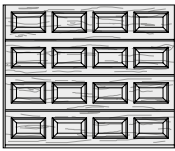
DOUBLE DOORS		 <b>L-ribbed Titan Metallic CH703</b> Outside Titan Metallic CH703*	 <b>L-ribbed Duragrain</b> Outside Decor Coating*	 <b>S-panelled Woodgrain</b>		No. of panels
Door sizes BR				Outside White	Outside Colour*	
Imperial	Metric					
11'0" x 6'6"	3353 x 2000	3319	3319	2698	3114	5
7'0"	3353 x 2125	3368	3368	2746	3188	5
12'0" x 6'6"	3658 x 2000	3498	3498	3112	3566	6
7'0"	3658 x 2125	3523	3523	3193	3675	6
13'0" x 6'6"	3962 x 2000	3769	3769	3311	3803	6
7'0"	3962 x 2125	3869	3869	3357	3879	6
14'0" x 6'6"	4267 x 2000	4003	4003	3446	3976	7
7'0"	4267 x 2125	4070	4070	3499	4062	7
14'6" x 6'6"	4420 x 2000	4076	4076	3531	4080	7
7'0"	4420 x 2125	4178	4178	3628	4211	7
15'0" x 6'6"	4572 x 2000	4160	4160	3636	4203	7
7'0"	4572 x 2125	4226	4226	3694	4297	7
15'6" x 6'6"	4725 x 2000	4239	4239	3638	4224	7
7'0"	4725 x 2125	4312	4312	3746	4369	7
16'0" x 6'6"	4877 x 2000	4316	4316	3740	4345	7
7'0"	4877 x 2125	4392	4392	3825	4468	7

**Low headroom**

Door with track application L, torsion spring at the back

£ 187

Intermediate sizes are available, please see your dealer for more details

# Hörmann Sectional Doors



## Optional extras for sectional doors

Colour surcharge	Price
RAL to choose colours (please ask to see colour chart)	per m <sup>2</sup> <b>99</b>
Door leaf in special colours (please ask to see colour chart)	per m <sup>2</sup> <b>195</b>

Fittings	Article no.	£
----------	-------------	---

The below listed handle sets are supplied with:

- Lock with profile half cylinder with side locking
- Template for lock knock-out on site

A factory lock knock-out will result in a longer delivery time and must be ordered explicitly (State position on order!)

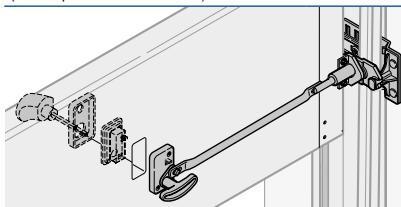

Door handle set, black plastic, prepared for profile cylinder	4015100	Each	<b>90</b>
Door handle set, cast aluminium RAL 9016, prepared for profile cylinder	3060831	Each	<b>251</b>
Door handle set, brown cast aluminium, prepared for profile cylinder	3076054	Each	<b>251</b>
Door handle set, brushed stainless steel, prepared for profile cylinder	3060835	Each	<b>251</b>

Emergency release	£
-------------------	---

Emergency release for sectional doors <b>with</b> handle set (Please state at point of order)	Each <b>60</b>
Emergency release for sectional doors <b>without</b> handle set (Please state at point of order)	Each <b>57</b>

Special anchor set	Article no.	£
--------------------	-------------	---

Set of 8 special anchors for side frame fitting up to LZ = 5500 mm	3056482	per set <b>80</b>
--	---------	-------------------

Reinforces the complete frame in difficult fitting situations

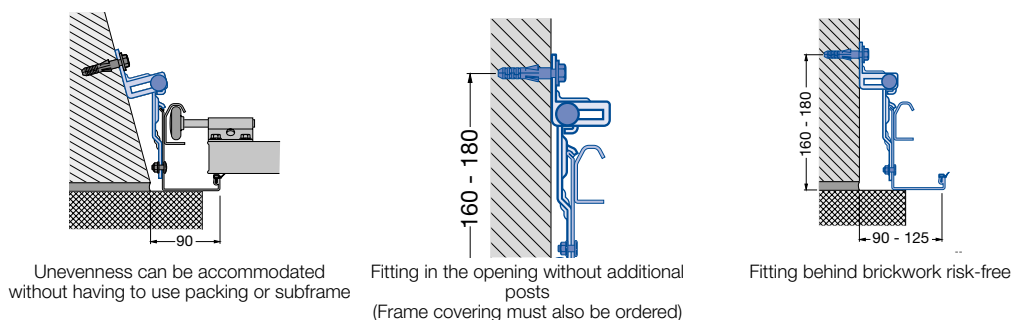

Frame cover profiles matching the colour of the door – 55mm x 19.5mm and 90mm x 19.5mm: prices are per pair
---

Door heights	White RAL 9016						Colour					
	Woodgrain		Silkgrain		Slategrain/Plaingrain		Woodgrain		Silkgrain		Slategrain / Plaingrain	
	55mm	90mm	55mm	90mm	55mm	90mm	55mm	90mm	55mm	90mm	55mm	90mm
2000mm	96	130	102	142	102	142	110	162	134	168	134	168
2080mm	100	136	107	148	107	148	115	169	140	175	140	175
2125mm	102	139	109	151	109	151	117	173	143	179	143	179
2250mm	108	147	115	160	115	160	124	183	151	189	151	189
2375mm	114	155	122	169	122	169	131	193	160	200	160	200
2500mm	120	163	128	178	128	178	138	203	168	210	168	210

Frame cover profiles matching the colour of the door – 55mm x 19.5mm and 90mm x 19.5mm: prices are per pair
---

Door heights	RAL to choose/CH 703						Decograin/Titan Metallic CH 703		Duragrain	
	Woodgrain		Slategrain / Plaingrain		Silkgrain		55mm	90mm	55mm	90mm
	55mm	90mm	55mm	90mm	55mm	90mm	55mm	90mm	55mm	90mm
2000mm	158	230	162	248	162	248	146	184	146	184
2080mm	165	240	169	258	169	258	152	192	152	192
2125mm	168	245	173	264	173	264	156	196	156	196
2250mm	178	259	183	279	183	279	165	207	165	207
2375mm	188	274	193	295	193	295	174	219	174	219
2500mm	198	288	203	310	203	310	183	230	183	230

For all available colours and finishes please refer to page 11. Plaingrain - New smooth surface finish in Plaingrain.

Retrofit fascias
------------------

Door heights	White RAL 9016			Colour			RAL to choose/CH 703		Decograin/Titan Metallic CH 703	Duragrain
	Woodgrain	Slategrain/Plaingrain	Silkgrain	Woodgrain	Slategrain/Plaingrain	Silkgrain	Woodgrain	Silkgrain	Decograin/Titan Metallic CH 703	Duragrain
Set: Renovation fascias to cover damaged brickwork edges consisting of: 3 angle sections, 69/40mm, each 3000mm long										
Price	246	267	267	311	332	332	351	371	279	279
Set: Fascia frame -95- consisting of: 2 fascias, 95mm, 2800mm long, 1 fascia 95mm, 3200mm long, fixing material										
Price	285	304	304	349	368	368	389	408	313	313

# Hörmann Sectional Doors



## Glazing options for sectional doors

LPU 42 with 16mm (for panelled) or 22mm (for ribbed) double pane in clear (DS) or crystal structure (DK)

Glazings				£/each
S0		With synthetic double pane, 16 mm or 22mm, clear / clear or crystal structure / crystal structure	LPU 42	158
S1		With synthetic double pane, 16 mm or 22mm, clear / clear or crystal structure / crystal structure	LPU 42	195
S2		With synthetic double pane, 16 mm or 22mm, clear / clear or crystal structure / crystal structure	LPU 42	195
S 10 – S 60		With synthetic double pane, 16 mm or 22mm, clear / clear or crystal structure / crystal structure	LPU 42	200
Type D		<ul style="list-style-type: none"> <li>With synthetic double pane, clear / clear or crystal structure / crystal structure, 16 mm</li> </ul>	LPU 42	158

For door width and glazing configuration, please refer to the 01-26 A price list

Sunrise Glazing (Available in white for UK modification whilst stocks last)				£/section
S10		<ul style="list-style-type: none"> <li>With synthetic double pane, 16 mm or 22mm</li> <li>Clear / clear or crystal structure / crystal structure</li> </ul>	For LPU 42 (4 × £200)	800
	LPU 42	Door width 2130 mm up to 2750 mm		
S20		<ul style="list-style-type: none"> <li>With synthetic double pane, 16 mm or 22mm</li> <li>Clear / clear or crystal structure / crystal structure</li> </ul>	For LPU 42 (5 × £200)	1000
	LPU 42	Door width 2755 mm up to 3500 mm		
S30		<ul style="list-style-type: none"> <li>With synthetic double pane, 16 mm or 22mm</li> <li>Clear / clear or crystal structure / crystal structure</li> </ul>	For LPU 42 (6 × £200)	1200
	LPU 42	Door width 3505 mm up to 4000 mm		
S40		<ul style="list-style-type: none"> <li>With synthetic double pane, 16 mm or 22mm</li> <li>Clear / clear or crystal structure / crystal structure</li> </ul>	For LPU 42 (7 × £200)	1400
	LPU 42	Door width 4005 mm up to 4750 mm		
S50		<ul style="list-style-type: none"> <li>With synthetic double pane, 16 mm or 22mm</li> <li>Clear / clear or crystal structure / crystal structure</li> </ul>	For LPU 42 (8 × £200)	1600
	LPU 42	Door width 4755 mm up to 5500 mm		
S60		<ul style="list-style-type: none"> <li>With synthetic double pane, 16 mm or 22mm</li> <li>Clear / clear or crystal structure / crystal structure</li> </ul>	For LPU 42 (8 × £200)	1600
	LPU 42	Door width 4755 mm up to 5500 mm		

Standard Colour Surcharges for the above windows. Please note: front window frame only is painted			Price
Standard colour for Decograin/Duragrain	For glazing S0, S1, S2 & type D	Each	44
RAL to choose	For glazing S0, S1, S2 & type D	Each	73

# Roller garage door RollMatic

Including operator

## Roller garage door RollMatic product description



### General information

Spring-compensated roller garage door for private applications. As standard, when the Hörmann operator RollMatic is used, version as internal roller garage door or external roller garage door, max. 10 door cycles per day according to the warranty conditions.

Manually operated version as internal roller garage door.

- **Wind load classes:**
  - LB to 3000 mm = wind load class 5
  - LB 3000 mm to 4000 mm = wind load class 4
  - LB 4000 mm to 4500 mm = wind load class 3
  - LB 4500 mm to 6000 mm = wind load class 2

- **Water tightness class 2**

### Frame

- Aluminium extrusion profile side guides with integrated slider profiles and brush seal. High-quality coating in door curtain colour.
  - Decopaint version:
    - colours matched to the Decopaint surface finish.
  - Decograin version – fitting behind the opening:
    - colours matched to the Decograin surface finish.
  - Decograin version – fitting in the opening:
    - high-quality plastic film coating in door curtain colour.
- Lintel and curtain cover made of sheet steel, high-quality powder coating in door curtain colour.
  - Decopaint / Decograin version:
    - colours matched to the Decopaint / Decograin surface finishes.
- Side cladding made of sheet steel, high-quality coating in the door curtain colour.
  - Decopaint / Decograin version:
    - colours matched to the Decopaint / Decograin surface finishes.

### Door curtain

Rolled aluminium profile foamed with polyurethane rigid foam, with integrated storm anchors, profile height 77 mm. Coloured versions with high-quality coil coating.

From LB > 5000 mm with high bottom profile in black.

#### Note:

All Hörmann roller garage doors correspond to the current state of the art in terms of their technical properties and the paint systems used. Pressure marks and abrasive wear are design-related and cannot be avoided. They do not impair the function and the durability of the roller garage door.

### Surface coating

#### Version in standard colours

#### Interior and exterior of door curtain:

- Standard colours based on the RAL colour chart:

RAL 9016	Traffic white	RAL 7035	Light grey
RAL 1015	Light ivory	RAL 7038	Agate grey
RAL 3003	Ruby red	RAL 8028	Terra brown
RAL 3004	Purple red	RAL 9001	Cream
RAL 5011	Steel blue	RAL 9005	Jet black
RAL 6005	Moss green	RAL 9006	White aluminium
RAL 7015	Slate grey	RAL 9007	Grey aluminium
RAL 7016	Anthracite grey		
- Chartwell Green
- Noir 2100 Sablé (Anthracite metallic) – at a surcharge

Dark colours should not be used for doors that are exposed to the sun.

#### IMPORTANT:

Our RollMatic garage doors are made of different materials. Particularly in the case of darker colours based on RAL 7015, RAL 7035, RAL 7016, RAL 8028, RAL 9005, RAL 9006 or RAL 9007 as well as the colour Noir 2100 Sablé, a differentiated colour perception between the sections and other coloured components of the door may occur depending on the lighting on-site. Such colour deviations do not warrant a complaint.

### Decopaint version with high-quality coating in timber design look

#### Decopaint version with door curtain paint on the outside and timber design look on the inside

- **Golden Oak** – medium brown surface with golden yellow shimmer and vibrant oak character
- **Rosewood** – reddish-brown stripey timber design

### Decograin version with high-quality plastic film coating with timber design (not available for external roller garage doors)

#### Door curtain, exterior:

- High-quality coating with UV-resistant timber design plastic film with embossed timber structure for an authentic timber character.
  - **Golden Oak** – medium brown surface with golden yellow shimmer and vibrant oak character
  - **Rosewood** – reddish-brown stripey timber design

#### Door curtain, interior:

- High-quality Terra brown coating based on RAL 8028

### Counterbalance

Tension spring assembly with lateral integral double tension springs. Cladding of internal roller garage door with transparent plastic and with aluminium profiles with integrated window cut-outs for external roller garage doors. Transmission of forces via two cables.

### Manually operated version (not possible with external roller garage door)

Door operated via chain hoist and interior / external handle.

### Fittings and closing devices

Lockable bottom profile with two-point locking for manually operated doors. Locking with the RollMatic operator.

### Chamfered bottom profile (optional, not available for manual operation)

Optional bottom profile to compensate for uneven floors (up to 300 mm height difference). Standard colour Jet black RAL 9005. Optional coating in door curtain colour possible. Colours matching the Decopaint surface finish (Decograin excluded).

### Delivery

1 unit including operator / chain hoist

### Glazing and / or ventilation grille arrangement (optional)

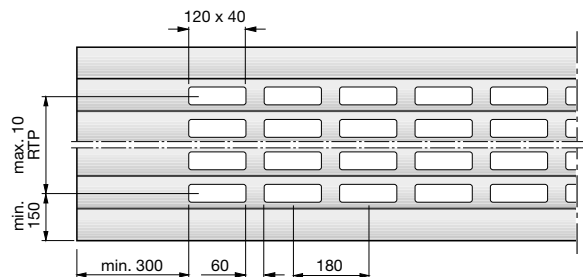

#### Note:

- Glazing / ventilation arrangement: only possible from the 2nd section from the bottom.
- For technical reasons, the glazing / ventilation arrangement in the curtain is only possible starting at the 8th visible section from the top.

- max.** = Maximum
- min.** = At least
- RTP** = Rolling shutter lath

# Roller garage door RollMatic

Including operator

## RollMatic operator product description

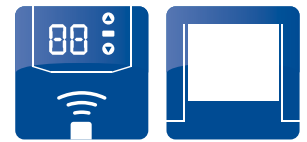

### Roller garage door operator RollMatic



Operator RollMatic series 2



Control RollMatic series 2  
In a separate housing

- Internal roller garage door: operator always on left when viewed from inside
- External roller garage door: operator as standard on left, right can be selected (not shown), integrated into curtain cover



**RollMatic  
Series 2**

Operator incl. control	Price in £	Included in the door price
<b>Product description</b>		
<b>Door cycles (Open / Close)</b>	Per day / per hour	25 / 10
<b>Suitable for:</b>	<ul style="list-style-type: none"> <li>• for commercial use</li> <li>• Max. door width</li> <li>• Max. door leaf surface</li> </ul>	<p>–</p> <p>6000</p> <p>15 m<sup>2</sup></p>
<b>Operator data</b>		
<b>Motor</b>		24 V DC gear drive
<b>Mains voltage</b>		230 V – 240 V AC
<b>Power input</b>		0.5 kW
<b>Opening speed<sup>3)</sup></b>		max. 20 cm/s <sup>3)</sup>
<b>Standby</b>		< 1 W
<b>Housing</b>		<ul style="list-style-type: none"> <li>• Plastic housing with an external operator.</li> <li>• Integrated into curtain cover with external roller garage doors.</li> </ul>
<b>Temperature range</b>		–20°C to +60°C
<b>Protection category</b>		Only suitable for dry rooms
<b>Control electronics</b>		
<b>Display</b>		Double 7-segment display
<b>Operation and programming</b>		Control element with Open / Close / PRG buttons
<b>Impulse control</b>		●
<b>Adjustable power limit</b>		●
<b>Adjustable soft start and soft stop</b>		●
<b>Adjustable operator light / partial opening / ventilation position</b>		●
<b>Adjustable automatic timer</b>		5 – 300 sec.
<b>Adjustable automatic timer / partial opening</b>		5 – 240 min.
<b>Adjustable / pre-set operator light</b>		30 – 600 sec. / 120 sec.
<b>High-speed opening</b>		●
<b>Equipment</b>		
<b>Hand transmitter (868 MHz)</b>		2 x button hand transmitter HSE 4 BS, textured surface (black)
<b>Integrated receiver (868 MHz)</b>		Bi-directional 7-channel receiver BS
<b>Integrated Bluetooth® receiver (2.4 GHz)</b>		●
<b>LED lighting</b>		●
<b>Connection for photocell / safety edge device</b>		● / ●
<b>Connection of external control elements</b>		●
<b>Connection for emergency battery</b>		●
<b>Connecting lead with CEE plug</b>		●
<b>Safety edge</b>		Roller garage door LB > 5000 mm – optical safety edge device installed at the factory with high bottom profile in black ensures safety as per DIN EN 13241-1, safety edge device with spiral cable

**Note:**

Installation of a photocell is required if the automatic timer is activated!

For optional extras. see door operators section in the 01-26 A dealer price list

# Roller garage door RollMatic

Including operator

## Internal roller garage door fitting dimensions



### Internal roller garage door – fitting behind the opening

Operator / chain hoist interior left

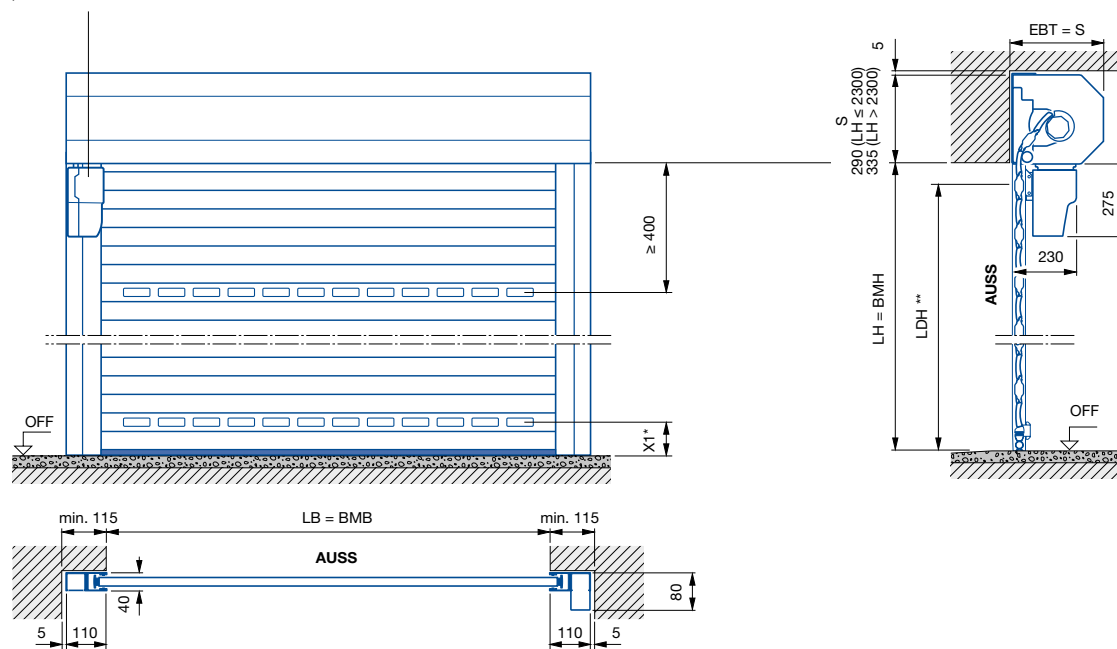

\* X1 – at least 150 mm (dimension without chamfered bottom profile)  
 \*\* See the “Dimensions” table on page 24

### Internal roller garage door – fitting in the opening

Operator / chain hoist interior left

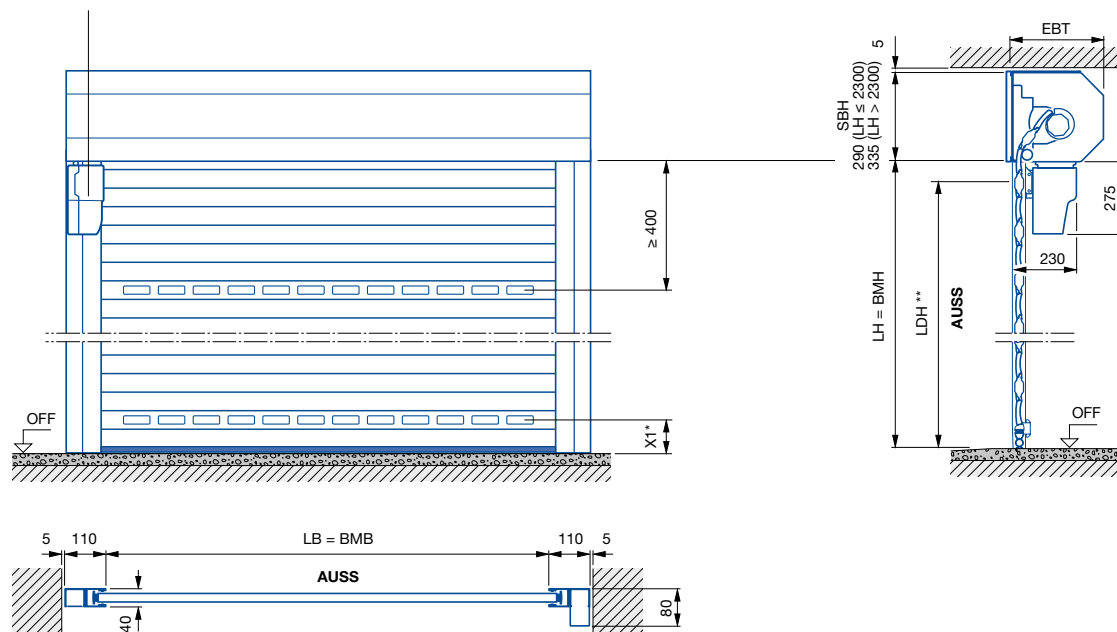

\* X1 – at least 150 mm (dimension without chamfered bottom profile)  
 \*\* See the “Dimensions” table on page 24

**An additional fascia panel is required!**  
 See accessories on page 27.

### Chamfered bottom profile

See page 27

# Roller garage door RollMatic

Including operator

## External roller garage door fitting dimensions



### External roller garage door – fitting in front of the opening

Operator as standard on left when viewed from outside. Operator on right optionally available.

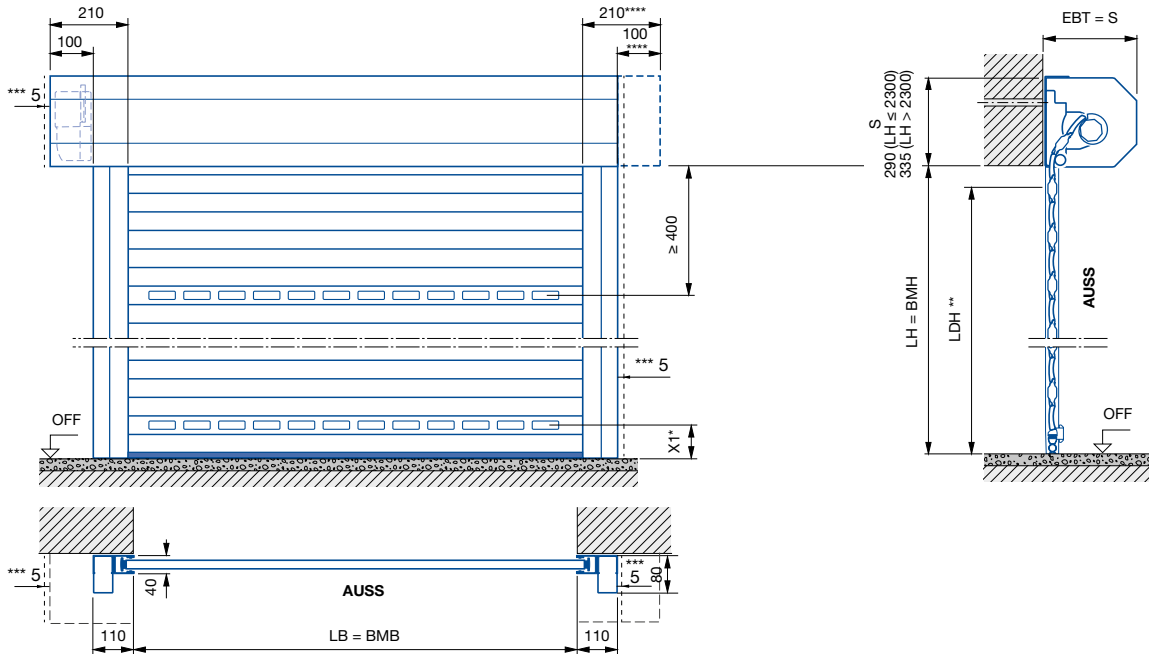

- \* X1 – at least 150 mm (dimension without chamfered bottom profile)
- \*\* See the table “Dimensions”

- \*\*\* At least 5 mm distance from fascia panel / side guide
- \*\*\*\* For a visually balanced appearance, the curtain cover can be ordered in a symmetrical version!  
Note: not possible with external roller garage doors LB > 5750 mm

### External roller garage door as entrance gate – fitting behind the opening (not self-supporting)

Operator as standard on left when viewed from inside, optionally operator on right.

- Fitting only possible when fitted on the all-round building structure
- A protective box IP 65 is required for the control, fitting inside on operator side

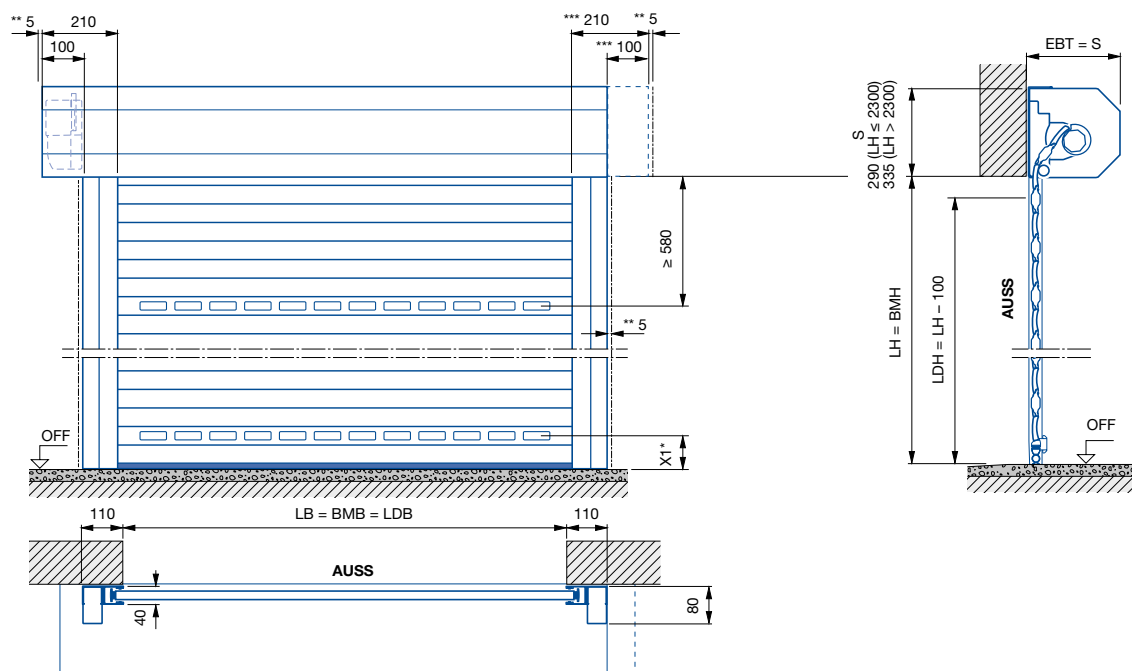

- \* X1 – at least 150 mm (dimension without chamfered bottom profile)
- \*\* At least 5 mm distance from fascia panel / side guide

- \*\*\* For a visually balanced appearance, the curtain cover can be ordered in a symmetrical version!  
Note: not possible with external roller garage doors LB > 5750 mm

### Chamfered bottom profile

See page 27

# Roller garage door RollMatic

Including operator

## Fitting dimensions



### External roller garage door as entrance gate – fitting in front of the opening (not self-supporting)

- Operator as standard on left when viewed from outside, optionally operator on right.
- Fitting only possible when fitted on the all-round building structure
- A protective box IP 65 is required for the control, fitting inside on operator side
- Additionally required: fitting compensation set and DuraBelt

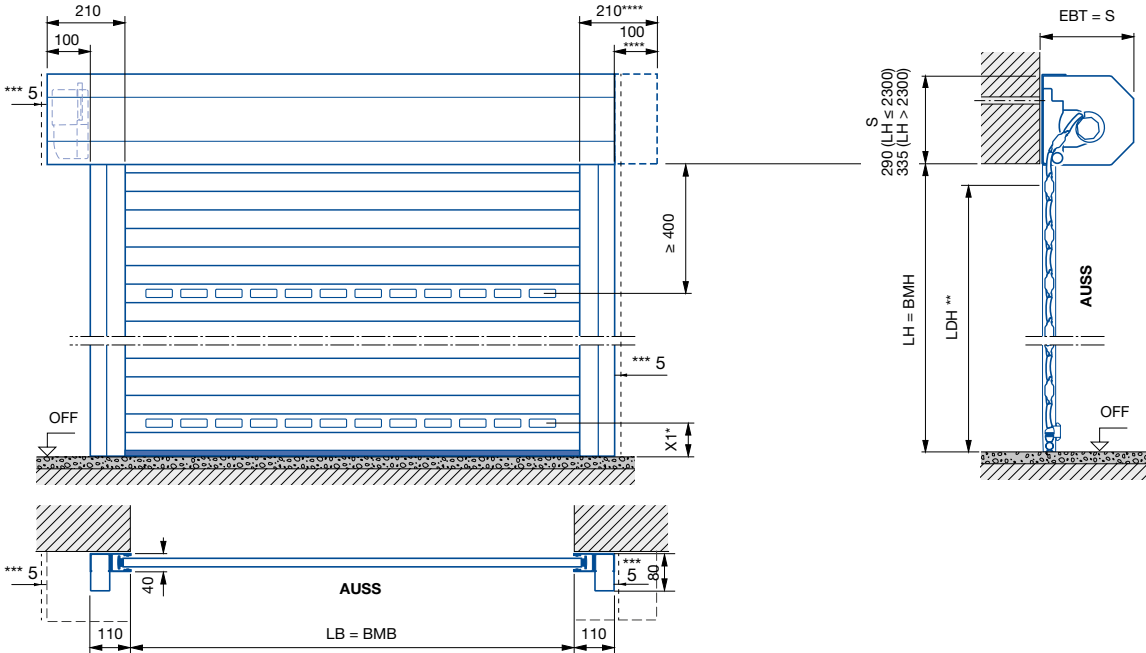

\* X1 – at least 150 mm (dimension without chamfered bottom profile)  
 \*\* See the table "Dimensions"

\*\*\* At least 5 mm distance from fascia panel / side guide  
 \*\*\*\* For a visually balanced appearance, the curtain cover can be ordered in a symmetrical version!  
 Note: not possible with external roller garage doors LB > 5750 mm

### Dimensions

	Version with operator RollMatic	Manually operated version (not available for external roller garage doors)
Clear passage height	= Clear height (ordering size height) – 100 mm	= Clear height (ordering size height) – 125 mm
Clear passage width	= Clear width (ordering size width)	= Clear width (ordering size width)

### Chamfered bottom profile

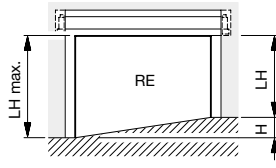
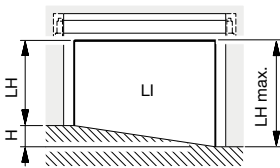

LH = (clear height on short side) = ordering size height (BMH)  
 LH max. = 3100 mm  
 LH min. = 1600 mm  
 H = Height difference max. 300 mm

Chamfered bottom profile – view of fitting side  
 Internal roller garage door from inside  
 External roller garage door from outside

**AUSS** Exterior  
**BMB** Ordering size width  
**BMH** Ordering size height  
**EBT** fitting depth  
**LB** Clear width  
**LH** Clear height  
**LDB** Clear passage width  
**LDH** Clear passage height

**OFF** Finished floor level (FFL)  
**RAMB** Overall frame width  
**RAMH** Overall frame height  
**S** required headroom  
**SBH** Additional fascia panel height  
**min.** At least  
**max.** Maximum





# Optional extras

For RollMatic roller garage door including operator



<b>Fitting compensation set</b> (to accommodate for unevenness on the building structure, recommended when fitting behind / in front of the opening)		<b>Article no.</b>		<b>£</b>
Fitting compensation set LH ≤ 2300		8991235	Per set	<b>68</b>
Fitting compensation set LH > 2300		8991236	Per set	<b>73</b>

<b>DuraBelt – winding unit</b>		<b>Article no.</b>		<b>£</b>
	LB 1000 – 1600 mm	2 winding units	Deduction per door	<b>96</b>
	LB 1601 – 3000 mm	3 winding units	Deduction per door	<b>143</b>
	LB 3001 – 5000 mm	5 winding units	Deduction per door	<b>239</b>
	LB 5001 – 6000 mm	6 winding units	Deduction per door	<b>285</b>
We recommend the use of the DuraBelt winding unit to reduce design-related abrasion on the door curtain to a minimum	Retrofit kit	2 winding units	8995301	Per door
	Up to LH 2300 mm	3 winding units	8995302	Per door
	Retrofit kit	2 winding units	8995303	Per door
	From LH 2301 mm	3 winding units	8995304	Per door

<b>Chamfered bottom profile</b>				<b>£</b>
Roller garage door RollMatic with chamfered bottom profile (not available in the surface finishes Golden Oak and Rosewood)		In black	Per m	<b>508</b>
		In door colour	Per m	<b>508</b>

<b>Symmetrical curtain cover</b>				<b>£</b>
Symmetrical curtain cover for a visually balanced appearance <u>Note:</u> not possible with external roller garage doors LB > 5750 mm			Per door	<b>No surcharge</b>

<b>Additional fascia panel</b>				<b>£</b>
Reinforcement of the fascia panel				
<b>Note:</b> Required for fitting in the opening!				
► State additional fascia panel height (SBH) and width!		In door colour	Per m	<b>104</b>

**Note:**  
State on door order, subsequent fitting is not possible.

**SBH** Fascia panel height  
**Min.** At least  
**max.** Maximum

  

<b>Optional extras</b>	<b>Article no.</b>		<b>£</b>	
<p><b>Glazing element</b> With clear synthetic pane, window cut-out 112 × 33 mm, black glazing frame on exterior, transparent on interior (maximum 10 sections per door, number of glazing elements depending on the door width)</p>		Per m	<b>46</b>	
<p><b>Ventilation grille</b> Black plastic Ventilation cross-section: approx. 13 cm<sup>2</sup>/grille (maximum of 10 sections per door, number of ventilation grilles depending on the door width)</p>		Per m	<b>46</b>	
<p><b>Brush seal for fascia panel</b></p>	LB up to 3000 mm	8991423	Per door	
	LB from 3000 mm to 5000 mm	8991044	Per door	
<b>Aluminium cover for side guides</b> (as standard with external roller garage door)			Per m	<b>72</b>

# Optional extras

## For RollMatic roller garage door including operator

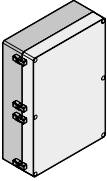

<b>2-coloured roller garage door RollMatic</b>				<b>£</b>
After technical clarification!				
	2-coloured roller garage door – frame and door curtain		Per door	<b>177</b>
	2-coloured door curtain (The individual section is only ever in one colour on the inside and outside)		Per door	<b>492</b>
<b>Cleaning and care</b>		<b>Article no.</b>		<b>£</b>
Cleaning cloth	Cleaning cloth (size 40 × 50 cm) Ready-to-use microfibre cloth for matt, glossy, film-coated and printed surfaces.	4018988	per unit	<b>11</b>
Cleaning and maintenance set	Content 1 × cleaner, 1 × cleaning sponge, 1 × 2-in-1 polish, 1 × polishing sponge, 2 × microfibre cloth, 1 × oil	4020356	Per set	<b>78</b>
<b>Optional extras for manually operated version</b>		<b>Article no.</b>		<b>£</b>
	Recessed handle	8991583	per unit	<b>174</b>
	Pull cord	8991581	per unit	<b>36</b>
<b>Accessories for control</b>		<b>Article no.</b>		<b>£</b>
	Protective box for control	8992240	per unit	<b>400</b>
<b>Accessories for operator RollMatic</b>		<b>Article no.</b>		<b>£</b>
	Accessory bag for permanent connection	4510779	per unit	<b>9</b>
	Motor connection line, 10 m	4510774	per unit	<b>44</b>
	Acoustic anti-lift kit	4510872	per unit	<b>96</b>
	Emergency battery HNA 18-4	4510095	per unit	<b>288</b>
<b>Emergency release</b>				<b>£</b>
	Exterior emergency release for internal roller garage door	436526	per unit	<b>144</b>
Exterior emergency release for external roller garage door	Exterior emergency release	436526	per unit	<b>144</b>
	Accessory bag for double secured release SE	437728	per unit	<b>12</b>
	Bowden cable, length 1 m, for double secured release SE	437986	per unit	<b>20</b>
<b>Note:</b> All 3 articles are required for the external roller garage door!				
<b>Bottom profile with closing edge safety device</b>				<b>£</b>
	Bottom profile retrofit kit with closing edge safety device <i>Notes:</i> with doors LB > 5000 mm high bottom profile in black	8992141	per unit	<b>526</b>
<b>Retrofit kit for operator RollMatic series 2</b>				<b>£</b>
	Retrofit kit for operator RollMatic series 2 for internal roller garage door, without SKS	8994670	per unit	<b>1567</b>
	Retrofit kit for operator RollMatic series 2 for external roller garage door, without SKS	8994672	per unit	<b>1567</b>
	Retrofit kit for operator RollMatic series 2, with SKS	8994671	per unit	<b>2105</b>
<b>Further accessories for operator RollMatic</b>		See the door operators in the 01-26 A dealer		

# Optional extras

## For RollMatic roller garage door including operator



### Fixed element

£

Element infill with roller garage door sections in RollMatic look. Position of sections does not match the roller garage door RollMatic.

Frame made of aluminium extrusion profile. Coated in colour of the element infill.

Decopaint and Decograin colours matching the Decopaint / Decograin surface finish.

RAMB max. 6000 mm. Reinforcement profile with BRB  $\geq$  5001 mm.

RAMH max. 3500 mm, maximum area of the fixed element 6 m<sup>2</sup>.

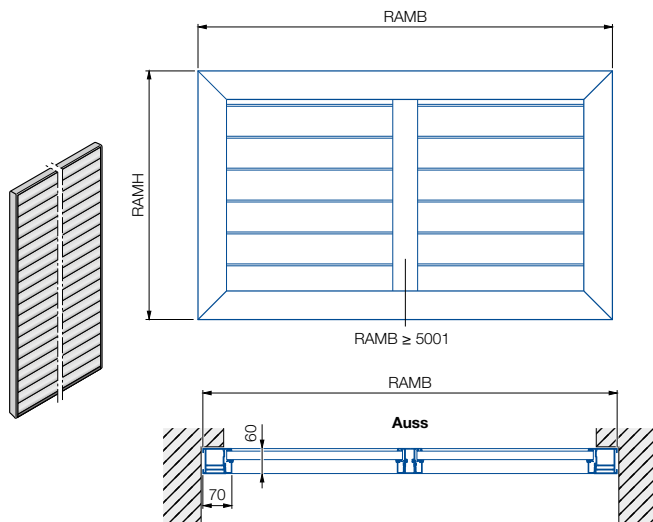

Based on RAL 9016	Per m <sup>2</sup>
Colour	Per m <sup>2</sup>
Decopaint	Per m <sup>2</sup>
Decograin	Per m <sup>2</sup>

701

**AUSS** Exterior  
**RAMB** Overall frame width  
**RAMH** Overall frame height

### Manufacturing dimensions

- Without reinforcement profile RAMB  $\leq$  5000 mm = RAMH min. 360 mm
- With reinforcement profile RAMB  $\geq$  5001 mm = RAMH min. 470 mm

### Note:

Only one side (width or height) may be > 2500 mm!

# Roller garage door RollMatic T

Including tubular drive

## Product description and fitting dimensions



### General information

Roller garage door with tubular drive and emergency crank handle for private use. With integral catch safety device and closing edge safety device as standard. Version as internal or external roller garage door, max. 10 door cycles per day according to warranty conditions.

- Wind load class 3 up to LB 3000 mm and LH 3000 m (FS 75 without wind lock)
- Wind load classes with wind locks (FS 105 from LB 3001 mm and / or LH 3001 mm):
  - LB 3000 mm to 4000 mm = wind load class 4
  - LB 4000 mm to 4500 mm = wind load class 3
  - LB 4500 mm to 6000 mm = wind load class 2
- Water tightness class 0
  - To LB 3000 mm and LH 3000 mm (FS 75)
- Water tightness class 2
  - From LB 3001 mm and / or LH 3001 mm (FS 105)

#### Note:

A second access point is required for installation as an external roller garage door!

### Frame

- Aluminium extrusion profile side guides with integrated strip brush profile and brush profile. High-quality coating in door curtain colour.
- Lintel cladding made of sheet steel with high-quality coating in door curtain colour.
- Curtain cover
  - To LH 3000 mm made of sheet steel, with high-quality coating in door curtain colour.
  - From LH 3001 mm made of aluminium, with high-quality coating in door curtain colour
- Side cladding for internal rolling shutters
  - To LB 3000 mm made of sheet steel, with high-quality coating in door curtain colour
  - From LB 3001 mm made of aluminium, with high-quality coating in door curtain colour
- Side cladding of external roller garage doors made of aluminium, with high-quality coating in door curtain colour.
- Side guides, lintel and curtain cover with high-quality coating in basic timber design colour in Decopaint / Decograin version.

### Door curtain

Rolled aluminium profile foamed with polyurethane rigid foam with plastic runners, 77 mm section height without ribbing in the profile. Coloured versions with high-quality coil coating.

#### Note:

All Hörmann roller garage doors correspond to the current state of the art in terms of their technical properties and the paint systems used. Pressure marks and abrasive wear are design-related and cannot be avoided. They do not impair the function and the durability of the roller garage door.

### Surface coating

#### Version in standard colours

##### Interior and exterior of door curtain:

- Standard colours based on the RAL colour chart:

RAL 9016	Traffic white	RAL 7035	Light grey
RAL 1015	Light ivory	RAL 7038	Agate grey
RAL 3003	Ruby red	RAL 8028	Terra brown
RAL 3004	Purple red	RAL 9001	Cream
RAL 5011	Steel blue	RAL 9005	Jet black
RAL 6005	Moss green	RAL 9006	White aluminium
RAL 7015	Slate grey	RAL 9007	Grey aluminium
RAL 7016	Anthracite grey		
- Chartwell Green
- Noir 2100 Sablé (Anthracite metallic) – at a surcharge

#### Note:

Dark colours should not be used for doors that are exposed to the sun.

#### IMPORTANT:

Our RollMatic garage doors are made of different materials. Particularly in the case of darker colours based on RAL 7015, RAL 7035, RAL 7016, RAL 8028, RAL 9005, RAL 9006 or RAL 9007 as well as the colour Noir 2100 Sablé, a differentiated colour perception between the sections and other coloured components of the door may occur depending on the lighting on-site. Such colour deviations do not warrant a complaint.

### Decopaint version with high-quality coating in timber design look

#### Door curtain with high-quality coating on the outside and timber design look on the inside

Curtain cover in basic colour of the Decopaint coating:

- **Golden Oak** – medium brown surface with golden yellow shimmer and vibrant oak character
- **Rosewood** – reddish-brown stripey timber design

### Decograin version with high-quality plastic film coating with timber design (not available for external roller garage doors)

#### Door curtain, exterior:

- High-quality coating with UV-resistant timber design plastic film with embossed timber structure for an authentic timber character.
  - **Golden Oak** – medium brown surface with golden yellow shimmer and vibrant oak character
  - **Rosewood** – reddish-brown stripey timber design

#### Door curtain, interior:

- High-quality Terra brown coating based on RAL 8028

### Operator data and control electronics

- Tubular drive with emergency hand drive and crank handle drive for operation in case of power failure, opening speed approx. 10 cm/s
  - Tubular drive technology with mechanically adjustable end-of-travel position (standard)
  - Tubular drives with electronically adjustable end-of-travel positions (optional)
- Door cycles (Open / Close)
  - Per day max. 10 / per hour max. 3
  - Tubular drive activation period max. 4 minutes per hour
- Operator available with impulse operation on left or right side (querying of the door position not possible)
- Control housing with integrated LED light
- Operation with 2 push buttons on the control housing
- Operation via hand transmitter HSE 4 BS 868 MHz BiSecur
- Optical closing edge safety device installed at the factory in the bottom profile ensures safety as per DIN EN 13241-1
  - Closing edge safety device with spiral cable (standard)
  - Radio closing edge safety device (optional, receiver integrated in control housing)
- Adjustable reversing behaviour
- Adjustable pre-warning phase
- Connection of external illumination possible
- Adjustable automatic timer
- Connecting option for one-way photocell EL 31

# Roller garage door RollMatic T

Including tubular drive



## Product description and fitting dimensions

### Standard equipment

- Door including tubular drive, emergency hand drive and complete curtain cover as standard.
- Control with 2 control buttons in the cover and integrated radio receiver 868 MHz BiSecur
- 2 x hand transmitter HSE 4 BS 868 MHz
- Connecting lead with plug
- Optical closing edge safety device (with spiral cable) with photocell in bottom profile
- External roller garage door with emergency release lock
- In the extended size range, additionally fitted as standard with:
  - Belt fitting
  - Movable bracket
  - With high bottom profile in black

### Chamfered bottom weather seal with visual closing edge guard, with coil cable (optional)

Optional bottom profile to compensate for uneven floors (up to 300 mm height difference). Standard colour Jet black RAL 9005. Optional coating in door curtain colour possible. Colours matching the Dekopaint surface finish (Deco grain excluded).

### Delivery

2-part packaging incl. operator

### Size range

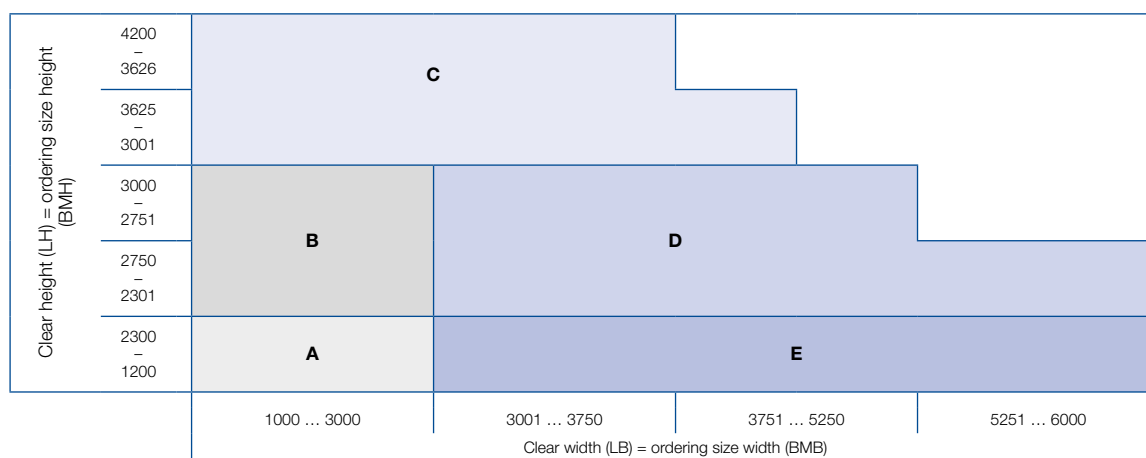

- A** EBT / S 290, LB ≤ 3000, FS 75, shaft 70 mm, no wind lock
- B** EBT / S 335, LB ≤ 3000, FS 75, shaft 70 mm, no wind lock
- C** EBT / S 360, LB > 3000, FS 105, shaft 80 mm, with wind locks
- D** EBT / S 335, LB 3001 – 6000, FS 105, shaft 80 mm, with wind locks
- E** EBT / S 290, LB 3001 – 6000, FS 105, shaft 80 mm, with wind locks

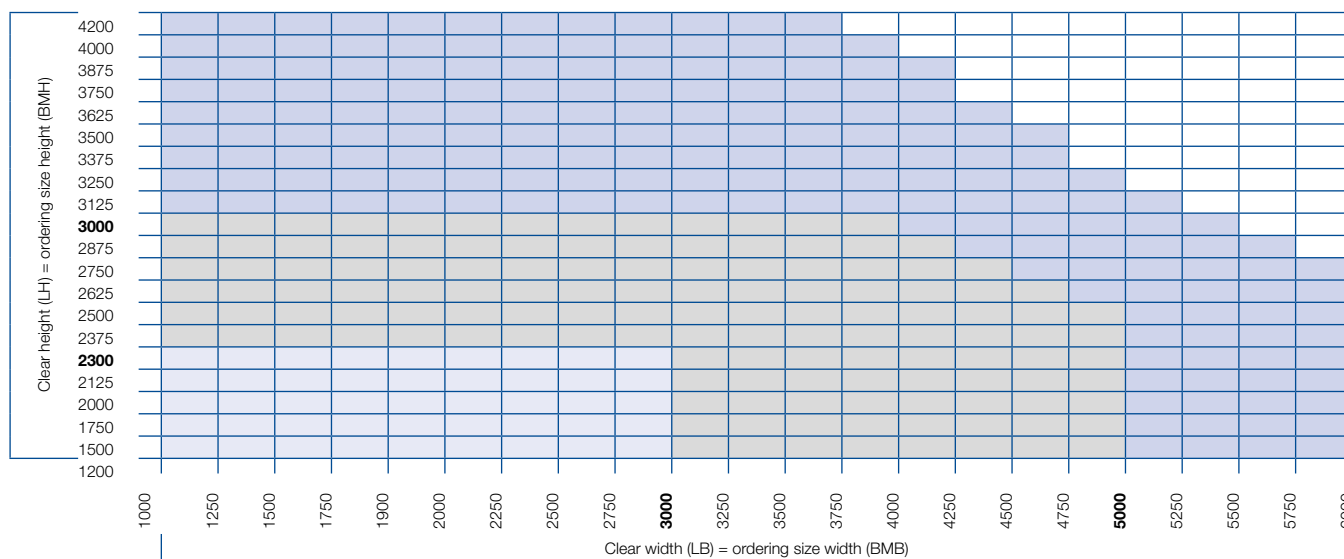

- Pre-assembly of the curtain on the barrel is available in this area.
- In this range, belt fitting is recommended.
- In the extended size range, belt fitting and movable brackets are fitted as standard. DuraBelt not possible.



# Roller garage door RollMatic T

Including tubular drive

## Product description and fitting dimensions



### External roller garage door – fitting in front of the opening

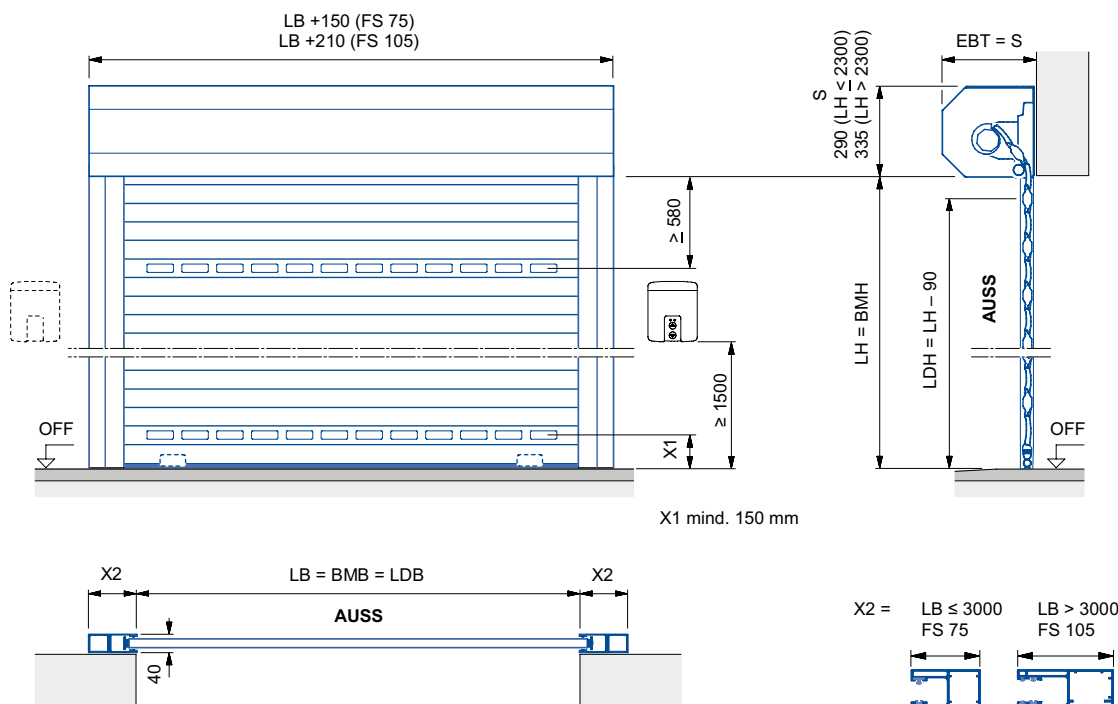

#### Note:

A second access point is required for installation as an external roller garage door!

### External roller garage door as entrance gate – fitting behind the opening (not self-supporting)

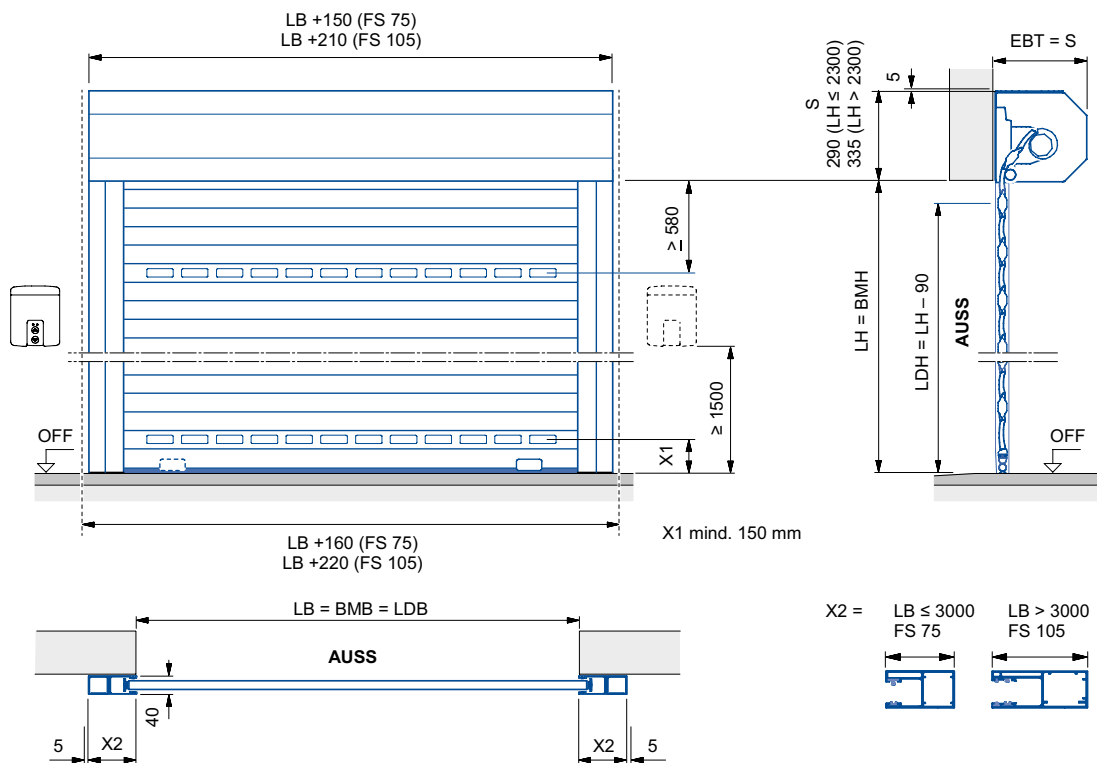

#### Recommendations:

- Operator as standard on left when viewed from outside, optionally operator on right.
- Fitting only possible when fitted on the all-round building structure
- A protective box IP 65 is required for the control

# Roller garage door RollMatic T

Including tubular drive

## Product description and fitting dimensions



### External roller garage door as entrance gate – fitting in front of the opening (not self-supporting)

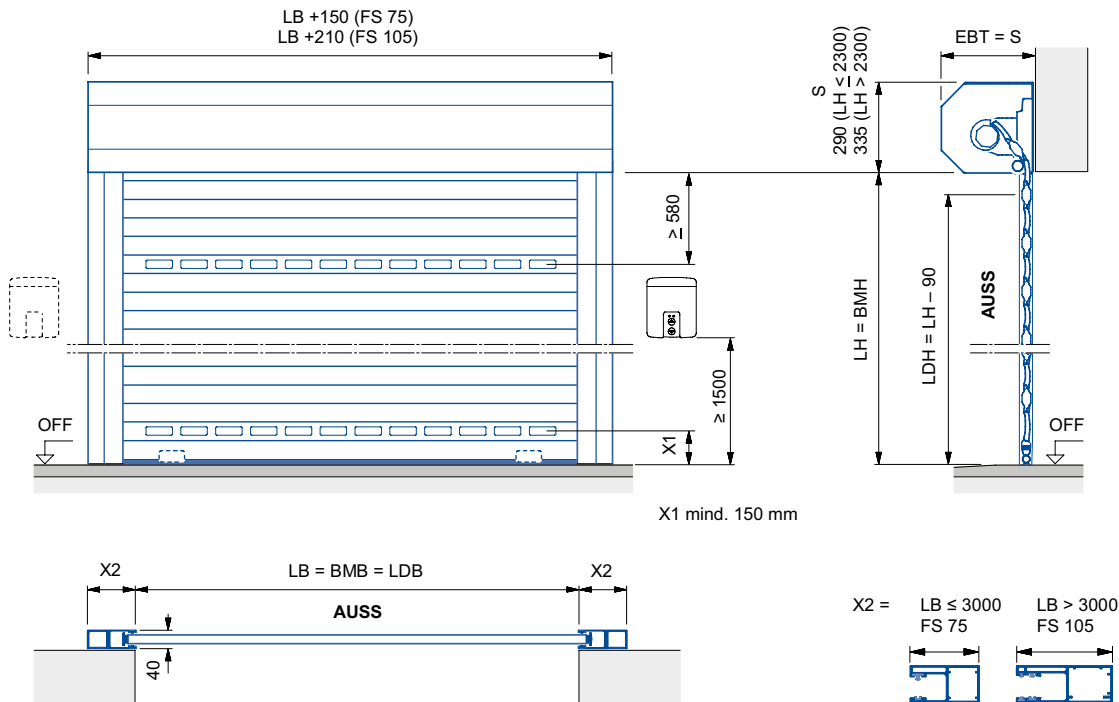

#### Recommendations:

- Operator as standard on left when viewed from outside, optionally operator on right
- Fitting only possible when fitted on the all-round building structure
- A protective box IP 65 is required for the control, fitting inside on operator side
- Additionally required: fitting compensation set and DuraBelt

#### Chamfered bottom profile

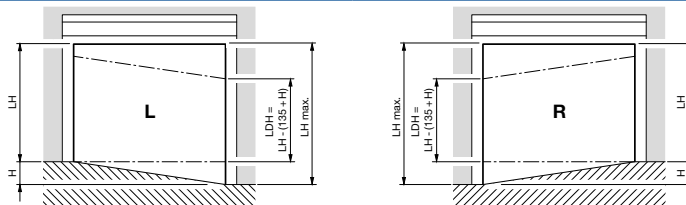

Chamfered bottom profile – view of fitting side  
Internal roller garage door from inside  
External roller garage door from outside

LH = (clear height on short side) = ordering size height (BMH)  
LH max. = 4200 mm  
LH min. = 1600 mm  
H = Height difference max. 300 mm

**AR** External rolling shutter  
**AUSS** Exterior  
**BMB** Ordering size width  
**BMH** Ordering size height  
**EBT** fitting depth  
**FS** Side guide

**IR** Internal rolling shutter  
**LB** Clear width  
**LDB** Clear passage width  
**LDH** Clear passage height  
**LH** Clear height  
**S** required headroom

**SBB** Additional fascia panel width  
**SBH** Additional fascia panel height  
**min.** Minimum  
**max.** Maximum  
**OFF** Finished floor level (FFL)

# Roller garage door RollMatic T

Including tubular drive

## Product description and fitting dimensions



### Glazing and / or ventilation grille arrangement (optional)

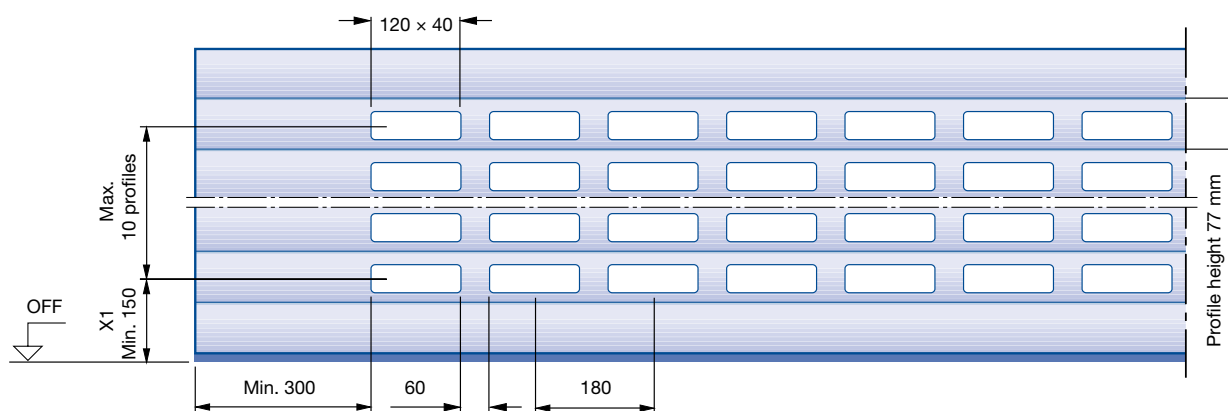

#### Recommendations:

- Glazing / ventilation arrangement: only possible from the 2nd section from the bottom.
- For technical reasons, the glazing / ventilation arrangement in the curtain is only possible starting at the 8th visible section from the top.

# Roller garage door RollMatic T

Including tubular drive

## Size range and prices



For a product description, see from page 30



Exterior  
Standard colours

### Prices for internal roller garage door RollMatic T – version with tubular drive

£

Clear height (LH) = ordering size height (BMH)	Clear width (LB) = ordering size width (BMB)											
	1000	1250	1500	1750	1900	2000	2250	2500	2750	3000	3250	3500
4200	3045	3147	3223	3223	3289	3388	3478	3579	3704	4338	4422	
4000	3009	3110	3186	3186	3251	3350	3439	3539	3663	4291	4374	
3875	2974	3074	3149	3149	3213	3312	3400	3499	3621	4244	4326	
3750	2938	3037	3112	3112	3175	3273	3361	3459	3580	4196	4278	
3625	2902	3001	3075	3075	3138	3234	3320	3419	3539	4148	4229	
3500	2867	2964	3038	3038	3100	3195	3281	3379	3497	4101	4182	
3375	2832	2928	3002	3002	3062	3157	3242	3339	3456	4054	4134	
3250	2795	2891	2964	2964	3024	3118	3203	3298	3415	4007	4085	
3125	2760	2854	2927	2927	2986	3080	3164	3258	3374	3959	4038	
3000	2534	2623	2693	2693	2777	2869	2953	3044	3155	3717	3803	
2875	2534	2623	2693	2693	2777	2869	2953	3044	3155	3717	3803	
2750	2495	2575	2641	2641	2721	2803	2884	2966	3067	3515	3597	
2625	2495	2575	2641	2641	2721	2803	2884	2966	3067	3515	3597	
2500	2456	2528	2590	2590	2662	2735	2812	2884	2984	3422	3500	
2375	2444	2516	2571	2571	2644	2721	2794	2869	2962	3396	3469	
2250	2413	2482	2534	2534	2601	2671	2740	2809	2896	3327	3396	
2125	2396	2459	2509	2509	2571	2637	2705	2770	2856	3280	3343	
2000	2383	2447	2495	2495	2558	2623	2682	2748	2837	3255	3319	
1750	2354	2413	2452	2452	2513	2571	2632	2693	2773	3185	3246	
1500	2315	2369	2400	2400	2456	2509	2558	2609	2689	3091	3142	
1200												

Only available in the priced size range listed! (Minimum production dimensions BR 1000 × 1200 mm)

- Pre-assembly of the curtain on the barrel is available in this area.
- In this range, belt fitting is recommended.
- In the extended size range, belt fitting and movable brackets are fitted as standard. DuraBelt not possible.

#### Fitting version

£

**Curtain pre-assembled on barrel** (size range up to BR 3000 × 2300 mm)

**Note:** No safety edge with radio possible.

Surcharge

43

**Belt fitting** (recommended for easier fitting on wider doors), as standard in the extended size range

**Note:** No safety edge with radio possible.

Surcharge

43

#### Surface finishes

**Noir 2100 Sablé (Anthracite metallic)**

£ per m<sup>2</sup>

41

**Decopaint**

High-quality coating in timber design look (Golden Oak or Rosewood) on the inside and outside

£ per m<sup>2</sup>

41

**Decograin**

High-quality plastic film coating in timber design look (Golden Oak or Rosewood) on the outside

£ per m<sup>2</sup>

75

**Note:**

External roller garage door not available with a Decograin surface finish!

# Roller garage door RollMatic T

Including tubular drive

## Size range and prices



For a product description, see from page 30

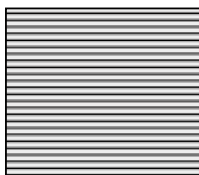

Exterior  
Standard colours

### Prices for internal roller garage door RollMatic T – version with tubular drive

£

Clear height (L-H) = ordering size height (BMH)											
	3501	3750	4000	4250	4500	4750	5000	5250	5500	5750	6000
4200	4513										
4000	4464	4557									
3875	4416	4507	4606								
3750	4367	4458	4555								
3625	4317	4408	4504	4623							
3500	4269	4358	4454	4571	4642						
3375	4220	4309	4403	4520	4589						
3250	4170	4259	4353	4468	4538	4636					
3125	4122	4209	4302	4417	4485	4584	4711				
3000	3891	3979	4134	4211	4137	4229	4345	4405			
2875	3891	3979	4083	4173	4099	4190	4305	4364	4423		
2750	3678	3761	3855	3926	4060	4151	4265	4324	4382	4566	
2625	3678	3761	3855	3926	4025	4112	4225	4264	4340	4527	
2500	3571	3649	3827	3919	3995	4070	4185	4242	4299	4356	
2375	3541	3615	3796	3886	3957	4030	4144	4202	4259	4316	
2250	3466	3532	3602	3688	3755	3825	3939	3996	4054	4111	
2125	3410	3476	3541	3621	3688	3755	3869	3927	3984	4041	
2000	3382	3446	3510	3593	3654	3717	3831	3889	3946	4003	
1750	3302	3362	3422	3494	3554	3615	3729	3786	3844	3901	
1500	3198	3250	3302	3370	3422	3476	3591	3648	3705	3763	
1200											

Only available in the priced size range listed! (Minimum production dimensions BR 1000 x 1200 mm)

- Pre-assembly of the curtain on the barrel is available in this area.
- In this range, belt fitting is recommended.
- In the extended size range, belt fitting and movable brackets are fitted as standard. DuraBelt not possible.

#### Fitting version

	£
<b>Curtain pre-assembled on barrel</b> (size range up to BR 3000 x 2300 mm) <b>Note:</b> No safety edge with radio possible.	Surcharge <b>43</b>
<b>Belt fitting</b> (recommended for easier fitting on wider doors), as standard in the extended size range <b>Note:</b> No safety edge with radio possible.	Surcharge <b>43</b>

#### Surface finishes

<b>Noir 2100 Sablé (Anthracite metallic)</b>	£ per m <sup>2</sup> <b>41</b>
<b>Decopaint</b> High-quality coating in timber design look (Golden Oak or Rosewood) on the inside and outside	£ per m <sup>2</sup> <b>41</b>
<b>Decograin</b> High-quality plastic film coating in timber design look (Golden Oak or Rosewood) on the outside	£ per m <sup>2</sup> <b>75</b>

**Note:**  
External roller garage door not available with a Decograin surface finish!

# Roller garage door RollMatic T

Including tubular drive

## Surcharges for optional extras

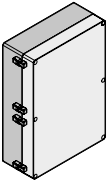

External rolling shutter				£	
Version as external roller garage door (fitting in front of the opening)					
<b>Note:</b>		Per door		71	
A second access point is required for installation as an external roller garage door.					
Funk		Article no.	£		
Radio receiver 868 MHz BiSecur with 1 x hand transmitter HSE 4 BS 868 MHz			Per door	Standard	
Operator		£			
Operator with mechanically adjustable end-of-travel position			Per door	Standard	
Operator with electronically adjustable end-of-travel positions			Per door	354	
<b>NEW.</b> Somfy operator 40 Nm			Per door	388	
<b>NEW.</b> Somfy operator 80 Nm			Per door	388	
Accessories for control				£	
	Protective box for control		8992240	per unit	400
Safety edge		Article no.	£		
Closing edge safety device with spiral cable			Per door	Standard	
Closing edge safety device with radio (receiver integrated in control housing)			Per door	256	
One-way photocell EL 31 as additional safety equipment		436210	per unit	194	
Chamfered bottom profile		£			
Roller garage door RollMatic T with chamfered bottom profile (not available in the surface finishes Golden Oak and Rosewood)		In black	Per m	508	
		In door colour	Per m	508	
Fitting compensation set		Article no.	£		
(to accommodate for unevenness on the building structure, recommended when fitting behind / in front of the opening)					
Fitting compensation set LH ≤ 2300	(FS 75)	8991193	Per set	68	
	(FS 105)	8991235	Per set	68	
Fitting compensation set LH > 2300	(FS 75)	8991194	Per set	75	
	(FS 105)	8991236	Per set	74	
DuraBelt – winding unit		Article no.	£		
We recommend the use of the DuraBelt winding unit to reduce design-related abrasion on the door curtain to a minimum	LB 1000 – 1600 mm	2 winding units	Surcharge per door	96	
	LB 1601 – 3000 mm	4 winding units	Surcharge per door	143	
	LB 3001 – 5000 mm	5 winding units	Surcharge per door	239	
	Retrofit kit	2 winding units	8995301	Per door	146
	Up to LH 2300 mm	3 winding units	8995302	Per door	212
	Retrofit kit	2 winding units	8995303	Per door	146
From LH 2301 mm	3 winding units	8995304	Per door	218	
Belt fitting		Article no.	£		
Belt fitting set		8992114	Per set	43	

# Roller garage door RollMatic T

Including tubular drive

Surcharges for optional extras



## Additional fascia panel £

Reinforcement of the fascia panel

### Recommendations:

- Required for fitting in the opening!
- State on door order, retrofitting is not possible!

In door colour

Per m

104

► State additional fascia panel height (SBH) and width!

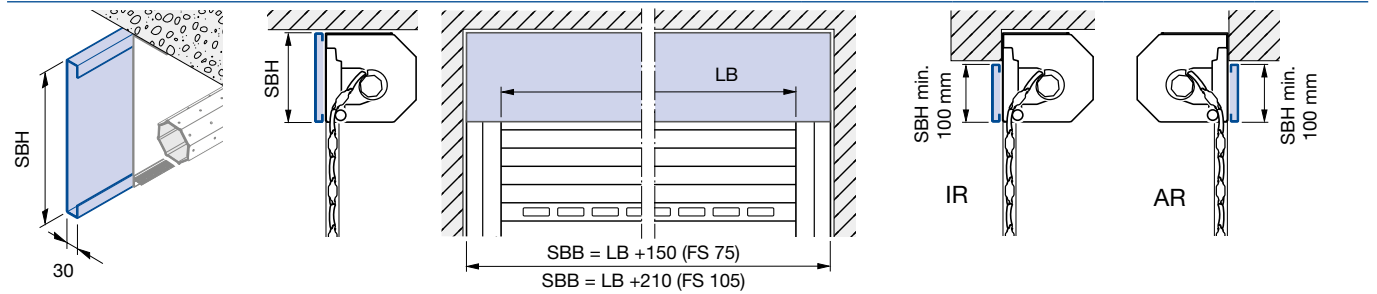

**AR** External rolling shutter  
**IR** Internal rolling shutter  
**LB** Clear width  
**SBB** Additional fascia panel width

**SBH** Additional fascia panel height  
**Min.** Minimum

## Emergency release Article no. £

Only for internal roller garage door!

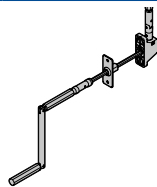

Exterior emergency release

8991692 per unit

294

### Note:

- LH min. 1700 mm
- Wall thickness ≤ 500 mm

## Optional extras Article no. £

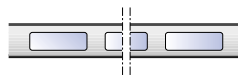

### Glazing element

With clear synthetic pane, window cut-out 112 × 33 mm, black glazing frame on exterior, transparent on interior (maximum 10 sections per door, number of glazing elements depending on the door width)

Per m

46

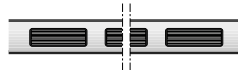

### Ventilation grille

Black plastic  
 Ventilation cross-section: approx. 13 cm<sup>2</sup>/grille (maximum of 10 sections per door, number of ventilation grilles depending on the door width)

Per m

46



### Brush seal for fascia panel

LB up to 3000 mm  
 LB from 3000 mm to 5000 mm

8991423 Per door  
 8991424 Per door

24  
 34

## Cleaning and care Article no. £

Cleaning cloth	Cleaning cloth (size 40 × 50 cm) Ready-to-use microfibre cloth for matt, glossy, film-coated and printed surfaces.	4018988	per unit	11
Cleaning and maintenance set	Content 1 × cleaner, 1 × cleaning sponge, 1 × 2-in-1 polish, 1 × polishing sponge, 2 × microfibre cloth, 1 × oil	4020356	Per set	78

## Key switch for impulse operation from outside Article no. £

- impulse
- Press-and-hold / push-to-lock function adjustable
- With 2 m connecting lead, 2-wire
- **2 impulse buttons** for controlling 2 operators or for choosing direction
- Max. switching capacity:
  - 30 V DC / 2.5 A (resistive load)
  - 230 V AC / 500 W (resistive load)
- Protection category IP 65



**STUP 50 (recessed):**  
 Dimensions (W × H × D): 80 × 80 × 15 mm  
 incl. recessed junction box: Ø 60 mm, depth 55 mm

4511648 per unit

89



**STAP 50 (surface-mounted):**  
 Dimensions (W × H × D): 80 × 80 × 65 mm

4511650 per unit

93

# Garage horizontal door RollMatic OD

Including side operator ProMatic

## Product description



### General information

Spring-compensated garage horizontal door for private applications. As standard when the Hörmann operator ProMatic is used, max. 25 door cycles per day according to the warranty conditions.

Version only as internal roller garage door.

- **Wind load classes:**
  - LB to 3000 mm = wind load class 3
  - LB 3000 mm to 3500 mm = wind load class 2
- Water tightness class 2

### Frame

- Vertical side guides made of aluminium extrusion profiles with integrated brush seal, with high-quality coating in door curtain colour. Horizontal side guides and fascia panel made of aluminium extrusion profiles, with high-quality coating in the door curtain colour
- Decopaint / Decograin version – colours matching the Decopaint / Decograin surface finish.

### Door curtain

- Rolled aluminium profile with rollers foamed with polyurethane rigid foam, profile height 77 mm. Coloured versions with high-quality coil coating.
- Bottom profile with floor seal.

#### Note:

All Hörmann roller garage doors correspond to the current state of the art in terms of their technical properties and the paint systems used. Pressure marks and abrasive wear are design-related and cannot be avoided. They do not impair the function and the durability of the roller garage door.

### Surface coating

#### Version in standard colours

#### Interior and exterior of door curtain:

- Standard colours based on the RAL colour chart:
 

RAL 9016 Traffic white	RAL 7035 Light grey
RAL 1015 Light ivory	RAL 7038 Agate grey
RAL 3003 Ruby red	RAL 8028 Terra brown
RAL 3004 Purple red	RAL 9001 Cream
RAL 5011 Steel blue	RAL 9005 Jet black
RAL 6005 Moss green	RAL 9006 White aluminium
RAL 7015 Slate grey	RAL 9007 Grey aluminium
RAL 7016 Anthracite grey	
- Chartwell Green
- Noir 2100 Sablé (Anthracite metallic) – at a surcharge

#### Note:

Dark colours should not be used for doors that are exposed to the sun.

#### IMPORTANT:

Our RollMatic garage doors are made of different materials. Particularly in the case of darker colours based on RAL 7015, RAL 7035, RAL 7016, RAL 8028, RAL 9005, RAL 9006 or RAL 9007 as well as the colour Noir 2100 Sablé, a differentiated colour perception between the sections and other coloured components of the door may occur depending on the lighting on-site. Such colour deviations do not warrant a complaint.

### Decograin version with high-quality plastic film coating in timber design

#### Door curtain, exterior:

- High-quality coating with UV-resistant timber design plastic film with embossed timber structure for an authentic timber character.
  - **Golden Oak** – medium brown surface with golden yellow shimmer and vibrant oak character
  - **Rosewood** – reddish-brown stripey timber design

#### Door curtain, interior:

- High-quality Terra brown coating based on RAL 8028

### Decopaint version with high-quality coating in timber design look

#### Interior and exterior of door curtain:

- **Golden Oak** – medium brown surface with golden yellow shimmer and vibrant oak character
- **Rosewood** – reddish-brown stripey timber design

### Counterbalance

Tension spring system with lateral integral multiple tension spring assemblies. Transmission of forces via a cable, including cable guide and safety catch.

### Closing devices

Locking with garage door operator.

### Delivery

1 unit including operator

### Glazing and / or ventilation grille arrangement (optional)

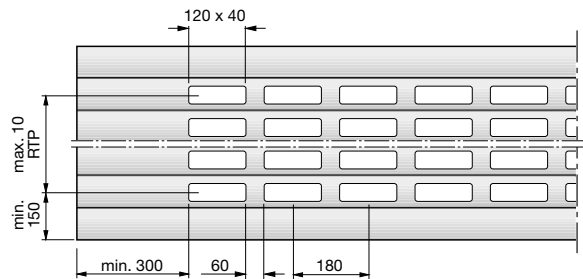

#### Note:

Glazing / ventilation arrangement: only possible from the 2nd section from the bottom.

### Operator (side operator)

- As standard with garage door operator ProMatic.
- Optional with garage door operator ProMatic Akku.
- Optional with garage door operator SupraMatic E
- Operator can be used on the left or right, please state on order!

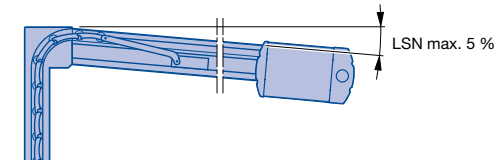

<b>AUSS</b>	Exterior
<b>BMB</b>	Ordering size width
<b>BMH</b>	Ordering size height
<b>LE</b>	Distance back with operator
<b>LB</b>	Clear width
<b>LH</b>	Clear height
<b>LDB</b>	Clear passage width
<b>LDH</b>	Clear passage height
<b>LML</b>	Structural opening width
<b>LSN</b>	Track slope
<b>max.</b>	Maximum
<b>min.</b>	At least
<b>OFF</b>	Finished floor level (FFL)
<b>RAMB</b>	Overall frame width
<b>RAMH</b>	Overall frame height
<b>S</b>	Lintel

# Garage horizontal door RollMatic OD

Including side operator ProMatic

## Fitting dimensions



### Fitting behind the opening

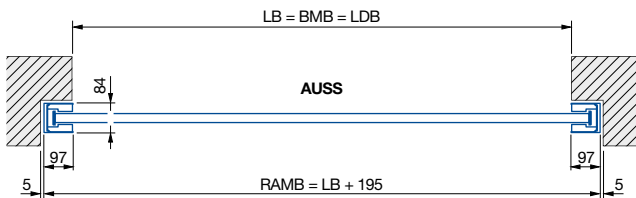
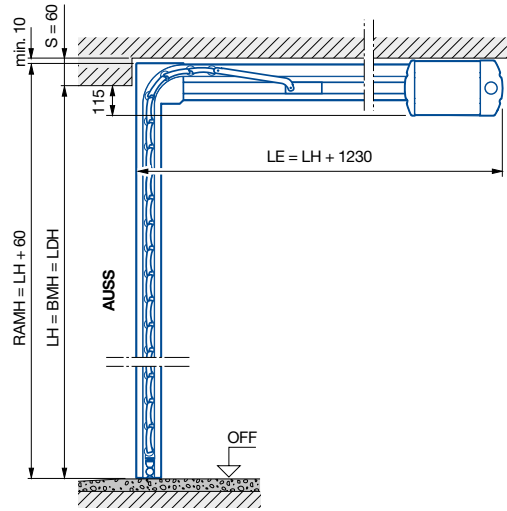
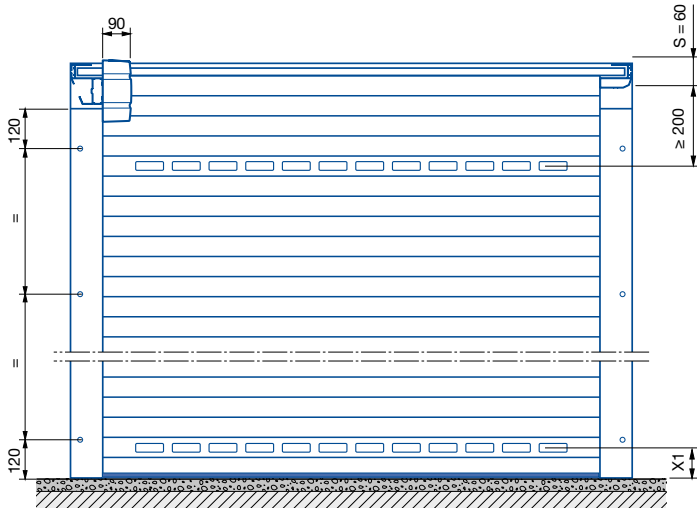

X1 min. 150

### fitting in the opening

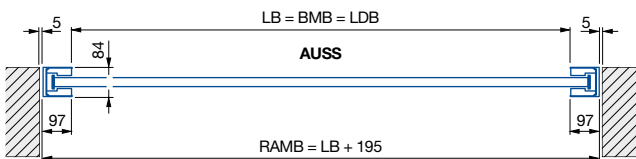
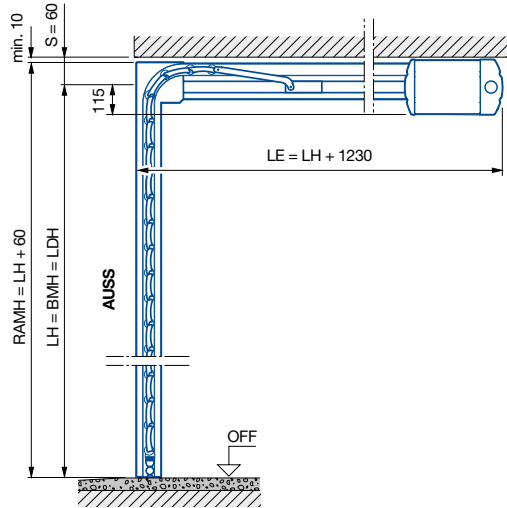
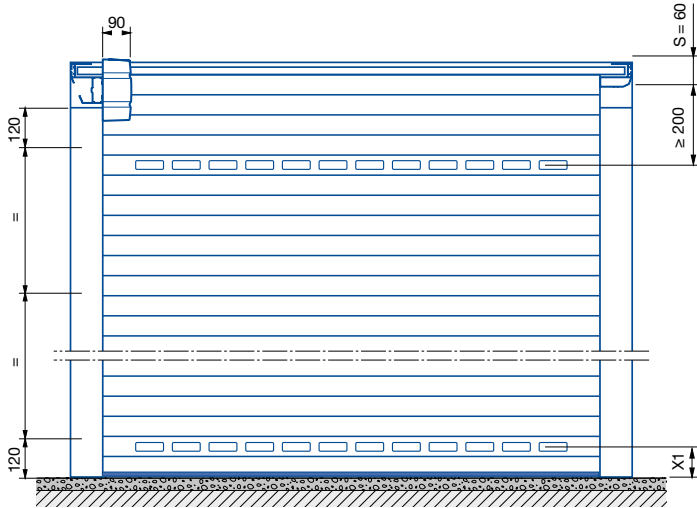

X1 min. 150

# Garage horizontal door RollMatic OD

Including side operator ProMatic

## Fitting dimensions



### Flush fitting in the opening with panel 95

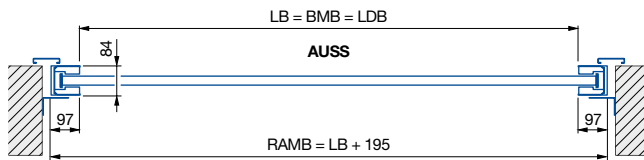
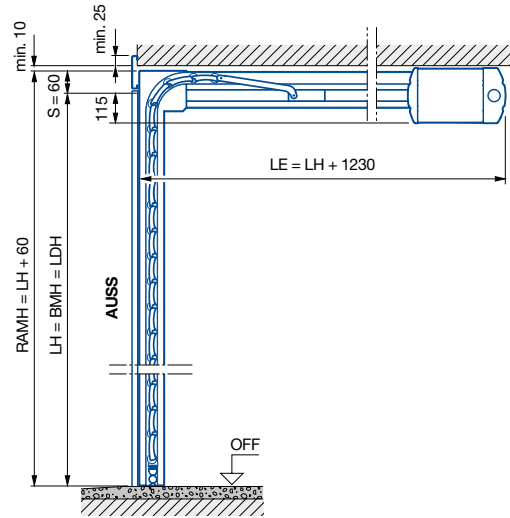
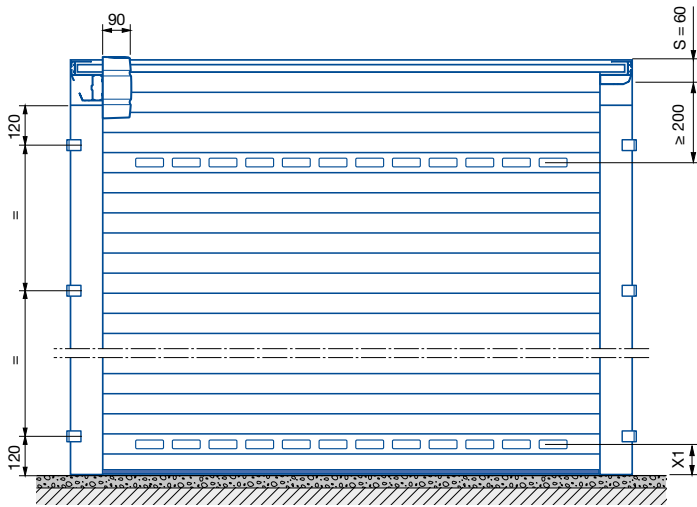

LB max. 3150  
LH max. 2700  
X1 min. 150

<b>AUSS</b>	Exterior
<b>BMB</b>	Ordering size width
<b>BMH</b>	Ordering size height
<b>LE</b>	Distance back with operator
<b>LB</b>	Clear width
<b>LH</b>	Clear height
<b>LDB</b>	Clear passage width
<b>LDH</b>	Clear passage height
<b>LML</b>	Structural opening width
<b>LSN</b>	Track slope
<b>max.</b>	Maximum
<b>min.</b>	At least
<b>OFF</b>	Finished floor level (FFL)
<b>RAMB</b>	Overall frame width
<b>RAMH</b>	Overall frame height
<b>S</b>	Lintel

# Garage horizontal door RollMatic OD

Including side operator ProMatic

Size range and prices



For a product description, see from page 40

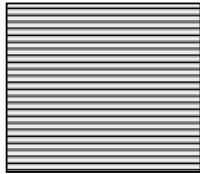

Exterior  
**White or Color**

(same price)

## Prices for overhead garage doors RollMatic OD

Clear height (LH) = ordering size height (BMH)	3000			2959	3034	3115	3184	3263	3332	3411
	2875			2905	2973	3037	3115	3190	3262	3326
	2750			2852	2907	2975	3050	3120	3186	3249
	2625			2790	2855	2906	2980	3052	3114	3170
	2500	2468	2463	2768	2824	2888	2958	3032	3089	3153
	2375	2405	2437	2611	2663	2729	2789	2850	2902	2959
	2250	2347	2404	2467	2518	2575	2637	2689	2743	2801
	2125	2305	2349	2405	2457	2511	2569	2620	2666	2726
	2000	2257	2299	2346	2395	2446	2501	2550	2598	2650
	1875	2208	2272	2293	2348	2404	2449	2504	2558	2611
1700										
	1250	1500	1750	2000	2250	2500	2750	3000	3250	3500

Only available in the priced size range listed! (Minimum production dimensions 1250 x 1700 mm)

### Surface finishes

<b>Noir 2100 Sablé (Anthracite metallic)</b>		£ per m <sup>2</sup>	<b>41</b>
<b>Decopaint</b>	High-quality coating in timber design look (Golden Oak or Rosewood) on the inside and outside	£ per m <sup>2</sup>	<b>41</b>
<b>Decograin</b>	High-quality plastic film coating in timber design look (Golden Oak or Rosewood) on the outside	£ per m <sup>2</sup>	<b>75</b>

### SupraMatic E, series 4

	<b>Optionally with garage door operator SupraMatic E, series 4</b> 2 x 4-button hand transmitter HSE 4 BS, textured surface (black) with chrome caps For a product description, see door operators section in the 01-26 A	Surcharge	<b>191</b>
---	---	-----------	------------

### ProMatic Akku, series 4

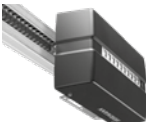
	<b>Optionally with garage door operator ProMatic Akku, series 4</b> 2 x 4-button hand transmitter HSE 4 BS, textured surface with plastic caps (black) For a product description, see door operators section in the 01-26 A	Surcharge	<b>431</b>
---	---	-----------	------------

<b>Replacement battery WA 24</b> (For a product description and possible number of door cycles, see door operators section in the 01-26 A)	438703	per unit	<b>404</b>
---	--------	----------	------------

### Special accessories

<b>Solar module SM 1-2</b> (For a product description, see door operators section in the 01-26 A)	4511942	per unit	<b>527</b>
--	---------	----------	------------



**2-coloured overhead garage door RollMatic OD** See page 44

**Optional extras for garage horizontal door RollMatic OD** See page 44

# Optional extras

For garage horizontal door RollMatic OD including side operator ProMatic

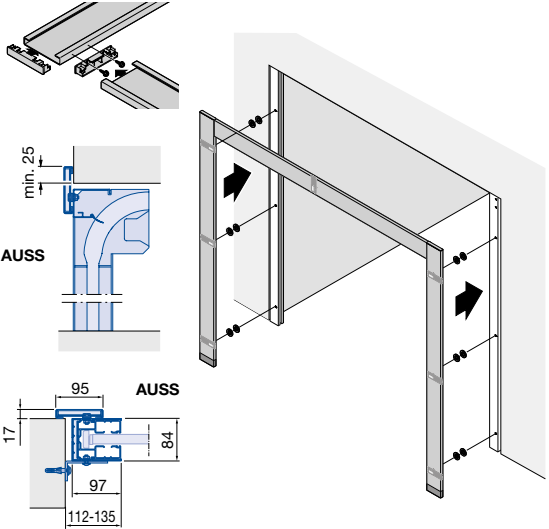

Optional extras		£	
	<b>Glazing element</b> With clear synthetic pane, window cut-out 112 x 33 mm, black glazing frame on exterior, transparent on interior (maximum 10 sections per door, number of glazing elements depending on the door width)	Per m <b>46</b>	
	<b>Ventilation grille</b> Black plastic Ventilation cross-section: approx. 13 cm <sup>2</sup> /grille (maximum of 10 sections per door, number of ventilation grilles depending on the door width)	Per m <b>46</b>	
2-coloured overhead garage door RollMatic OD		£	
	2-coloured roller garage door – frame and door curtain	Per door <b>177</b>	
After technical clarification!	2-coloured door curtain (The individual section is only ever in one colour on the inside and outside)	Per door <b>492</b>	
Retrofit fascias for flush fitting		£	
<b>Set: fascia frame OD</b> As cover for lintel and frame with flush-fitting installation and for renovations			
<b>NEW. Set 1: For use with doors up to LB max. 3150 mm and LH max. 2700 mm</b>		White, based on RAL 9016 or Color Per set <b>392</b>	
<b>Consisting of:</b>	<ul style="list-style-type: none"> <li>• 2 panels, width 95 mm, length 2800 mm each</li> <li>• 1 panel, width 95 mm, length 3200 mm</li> <li>• Including additional fixing material for panel and door</li> <li>• 2 plastic panel shoes (black)</li> </ul>		
<b>NEW. Set 2: For use with doors up to LB max. 3500 mm and LH max. 2700 mm</b>		White, based on RAL 9016 or Color Per set <b>429</b>	
<b>Consisting of:</b>	<ul style="list-style-type: none"> <li>• 2 panels, width 95 mm, length 2800 mm each</li> <li>• 1 panel, width 95 mm, length 5500 mm</li> <li>• Including additional fixing material for panel and door</li> <li>• 2 plastic panel shoes (black)</li> </ul>		
<b>Note:</b> The vertical tracks and the fascia panel are pre-drilled at the factory if this fitting is selected.			
 <p><b>AUSS</b> Exterior <b>Min.</b> At least</p>			
Cleaning and care		Article no.	£
Cleaning cloth	Cleaning cloth (size 40 x 50 cm) Ready-to-use microfibre cloth for matt, glossy, film-coated and printed surfaces.	4018988	per unit <b>11</b>
Cleaning and maintenance set	Content 1 x cleaner, 1 x cleaning sponge, 1 x 2-in-1 polish, 1 x polishing sponge, 2 x microfibre cloth, 1 x oil	4020356	Per set <b>78</b>
<b>Emergency release NET 4</b> (required if there is no second entrance)		See the door operators in the 01-26 A dealer	
<b>Accessories for operator ProMatic / SupraMatic E</b>		See the door operators in the 01-26 A dealer	

# Good reasons to try Hörmann garage doors

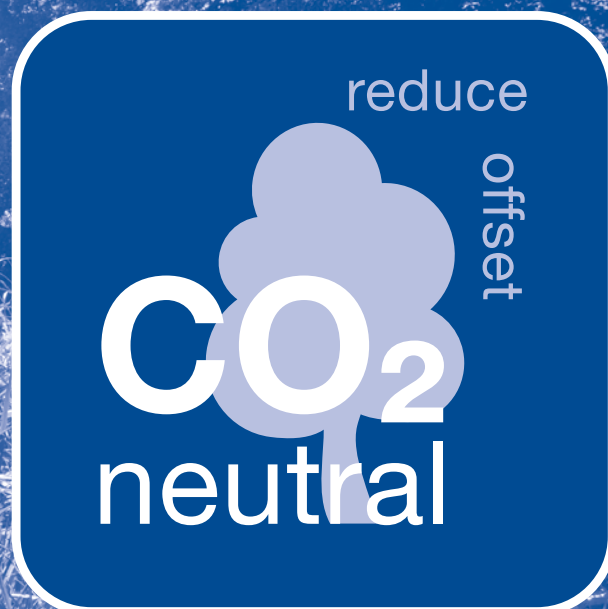

**ClimatePartner**  
certified product  
[climate-id.com/XNEBKC](https://climate-id.com/XNEBKC)



CO<sub>2</sub> measure  
reduce  
contribute

Learn more about our sustainability  
strategy at  
[www.hoermann.com/sustainability](https://www.hoermann.com/sustainability)



We think and act green

**Carbon neutral as standard with all sectional doors, up-and-over doors and roller garage doors**

**HÖRMANN**

# NT 60 side doors

For RollMatic roller garage door / RollMatic OD overhead garage door  
single-leaf side doors with corner frame made of aluminium profiles



## Product description

Subject to changes

### General information

Door set for private use

#### Recommendations:

- Doors cannot be driven!
- For internal fitting please state when ordering, subsequent change is not possible.

### Door leaf and frame

Door leaf frame and frame made of aluminium extrusion profiles (standard profile, without thermal break), depth 60 mm, 3-sided double door seal, double lip seal in the threshold area.

Door infill: Roller garage door sections in RollMatic look.

Rolled aluminium profile foamed with polyurethane rigid foam, profile height 77 mm. Coloured versions with two-layer coil coating with a paint system based on a high-quality polyurethane coated with polyamide.

Position of sections does not match the roller garage door RollMatic. Glazing and ventilation grilles arranged as in the RollMatic roller garage door.

Frame including plug holes under the cover strip.

#### Thermal insulation value\*:

- Fitted side door NT 60  $U = 5.6 \text{ W}/(\text{m}^2\cdot\text{K})$
- \* In relation to door size 1250 x 2200 mm

### Version – wide leaf frame

Lever height: 1050 mm

#### Opening inwards

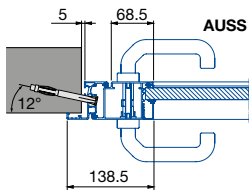

#### Opening outwards

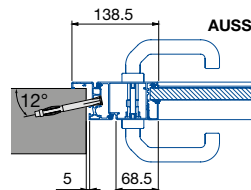

### Fittings and closing devices

- Lever handle set with oval rose escutcheons in black plastic, prepared for profile cylinder
- Lock with profile cylinder, keys to differ or keys to pass
- Hinges optionally in black, white or aluminium natural finish

The handle set version can be selected at a surcharge (see page 52)

### Surface coating

#### Color based on RAL

- Door infill in Color on interior and exterior
- Standard colours based on the RAL colour chart:

RAL 9016	Traffic white	RAL 7035	Light grey
RAL 1015	Light ivory	RAL 7038	Agate grey
RAL 3003	Ruby red	RAL 8028	Terra brown
RAL 3004	Purple red	RAL 9001	Cream
RAL 5011	Steel blue	RAL 9005	Jet black
RAL 6005	Moss green	RAL 9006	White aluminium
RAL 7015	Slate grey	RAL 9007	Grey aluminium
RAL 7016	Anthracite grey		
- Chartwell Green
- Noir 2100 Sablé (Anthracite metallic) – at a surcharge

#### \* IMPORTANT:

Despite the use of state-of-the-art colour coating systems, colour deviations cannot be ruled out, specifically in metallic colours such as RAL 9006 or RAL 9007.

### Decopaint version with high-quality coating in timber design look

Decopaint version with paint on the outside and timber design look on the inside

- **Golden Oak** – medium brown surface with golden yellow shimmer and vibrant oak character
- **Rosewood** – reddish-brown stripey timber design

### Decograin version with high-quality plastic film coating in timber design

Decograin version with plastic film coating with timber design

- **Exterior:** Coated with UV-resistant timber design plastic film with embossed timber structure for an authentic timber look.
  - **Golden Oak** – medium brown surface with golden yellow shimmer and vibrant oak character
  - **Rosewood** – reddish-brown stripey timber design
- **Interior:** Coated in RAL 8028 Terra brown

### Notes on surface coatings

Deviations in colour are to be expected due to the use of different base materials, such as aluminium and steel, and textures, as well as due to varying production processes and locations

Despite the use of state-of-the-art colour coating systems, colour deviations cannot be ruled out, specifically in metallic colours such as RAL 9006.

### Glazing / ventilation grille

- Glazing / ventilation grille optional
- Not possible in the bottom section and in the lock area (13th and 14th section from the bottom)

# NT 60 side doors

For RollMatic roller garage door / RollMatic OD overhead garage door  
single-leaf side doors with corner frame made of aluminium profiles



## Product description

Subject to changes

### Fitting dimensions

#### Internal fitting (opening inwards)

Matching  
Internal roller garage doors  
RollMatic  
Overhead garage doors  
RollMatic OD

Matching  
External roller garage doors  
RollMatic

#### External fitting (opening outwards)

Matching  
Internal roller garage doors  
RollMatic  
Overhead garage doors  
RollMatic OD

Matching  
External roller garage doors  
RollMatic

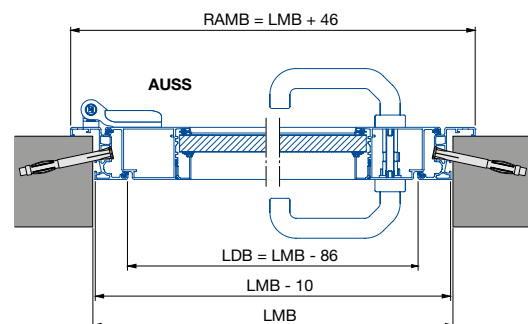
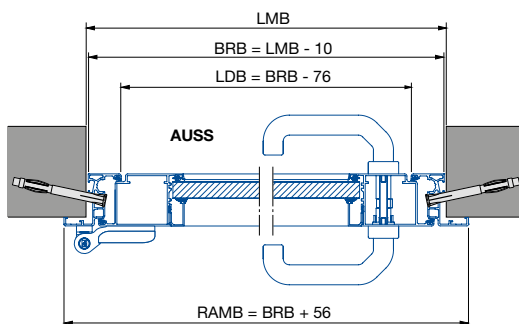
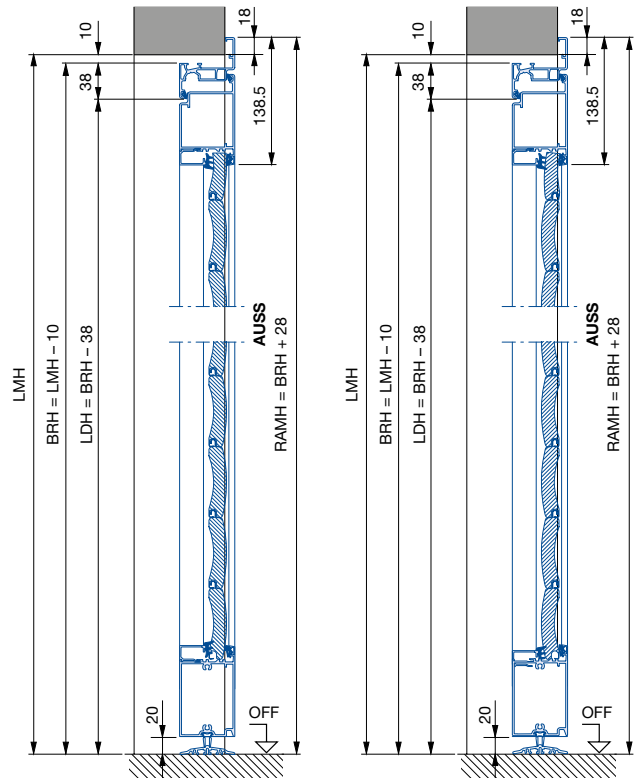
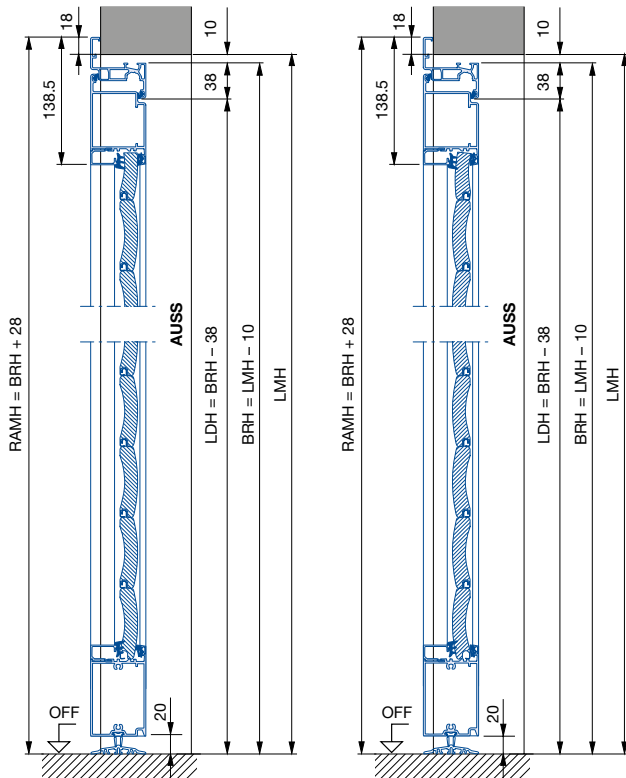

- AUSS** Exterior
- BRB** Nominal size width
- BRH** Nominal height
- INNE** Interior
- LDB** Clear passage width
- LDH** Clear passage height
- LI** Left
- LML** Structural opening width (ordering size)
- LMH** Structural opening height (ordering size)
- RAMB** Overall frame width
- RAMH** Overall frame height
- IR** Right
- OFF** Finished floor level (FFL)

# NT 60 side doors

For roller garage door RollMatic / garage horizontal door RollMatic OD  
single-leaf side doors with block frame made of aluminium profiles



## Product description

Subject to changes

### General information

Door set for private use

#### Recommendations:

- Doors cannot be driven!
- For internal fitting please state when ordering, subsequent change is not possible.

### Door leaf and frame

Door leaf frame and frame made of aluminium extrusion profiles (standard profile, without thermal break), depth 60 mm, 3-sided double door seal, double lip seal in the threshold area.

Door infill: Roller garage door sections in RollMatic look. Position of sections does not match the roller garage door RollMatic. Glazing and ventilation grilles arranged as in the RollMatic roller garage door.

#### Thermal insulation value\*:

- Fitted side door NT 60  $U = 5.6 \text{ W}/(\text{m}^2\cdot\text{K})$
- \* In relation to door size 1250 x 2200 mm

### Version – wide leaf frame

Lever height: 1050 mm

#### Opening inwards

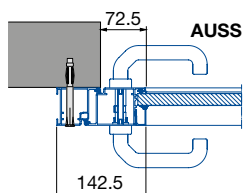

#### Opening inwards or outwards

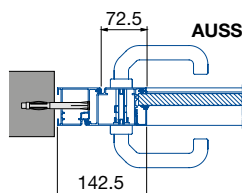

### Fittings and closing devices

- Lever handle set with oval rose escutcheons in black plastic, prepared for profile cylinder
- Lock with profile cylinder, keys to differ or keys to pass
- Hinges optionally in black, white or aluminium natural finish

The handle set version can be selected at a surcharge (see page 52).

### Surface coating

#### Coloured design with high-quality coating based on RAL

- Door infill in Color on interior and exterior
- Standard colours based on the RAL colour chart:

RAL 9016	Traffic white	RAL 7035	Light grey
RAL 1015	Light ivory	RAL 7038	Agate grey
RAL 3003	Ruby red	RAL 8028	Terra brown
RAL 3004	Purple red	RAL 9001	Cream
RAL 5011	Steel blue	RAL 9005	Jet black
RAL 6005	Moss green	RAL 9006	White aluminium
RAL 7015	Slate grey	RAL 9007	Grey aluminium
RAL 7016	Anthracite grey		
- Chartwell Green
- Noir 2100 Sablé (Anthracite metallic) – at a surcharge

#### \* IMPORTANT:

Despite the use of state-of-the-art colour coating systems, colour deviations cannot be ruled out, specifically in metallic colours such as RAL 9006 or RAL 9007.

### Decopaint version with high-quality coating in timber design look

#### Decopaint version with paint on the outside and timber design look on the inside

- **Golden Oak** – medium brown surface with golden yellow shimmer and vibrant oak character
- **Rosewood** – reddish-brown stripey timber design

### Decograin version with high-quality plastic film coating in timber design

Decograin version with plastic film coating with timber design

- **Exterior:** Coated with UV-resistant timber design plastic film with embossed timber structure for an authentic timber look.
  - **Golden Oak** – medium brown surface with golden yellow shimmer and vibrant oak character
  - **Rosewood** – reddish-brown stripey timber design
- **Interior:** Coated in RAL 8028 Terra brown

### Notes on surface coatings

Deviations in colour are to be expected due to the use of different base materials, such as aluminium and steel, and textures, as well as due to varying production processes and locations

Despite the use of state-of-the-art colour coating systems, Colour deviations cannot be ruled out, specifically in metallic colours such as RAL 9006.

### Glazing / ventilation grille

- Glazing / ventilation grille optional
- Not possible in the bottom section and in the lock area (13th and 14th section from the bottom)

# NT 60 side doors

For roller garage door RollMatic / garage horizontal door RollMatic OD  
single-leaf side doors with block frame made of aluminium profiles



## Product description

Subject to changes

### Fitting dimensions

#### Fitting behind the opening (opening inwards)

Matching  
Internal roller garage doors  
RollMatic  
Overhead garage doors  
RollMatic OD

Matching  
External roller garage doors  
RollMatic

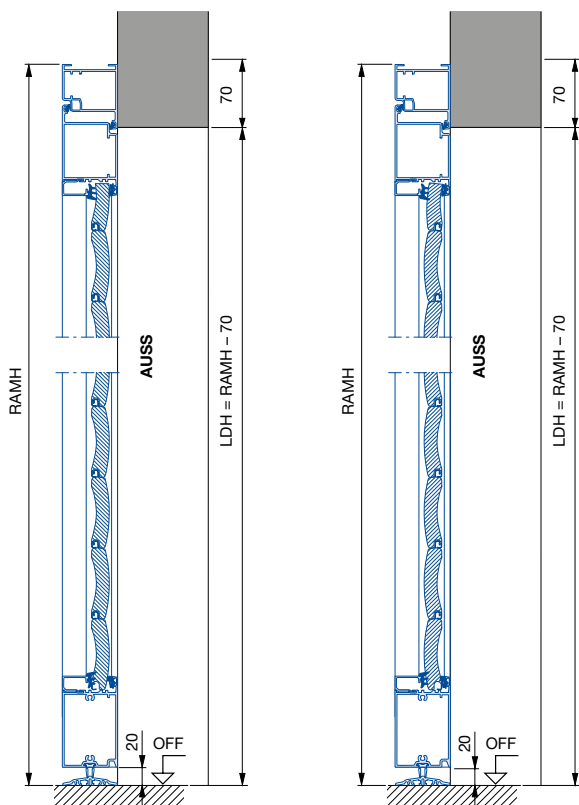

#### Fitting in the opening (opening inwards)

Matching  
Internal roller garage doors  
RollMatic  
Overhead garage doors  
RollMatic OD

Matching  
External roller garage doors  
RollMatic

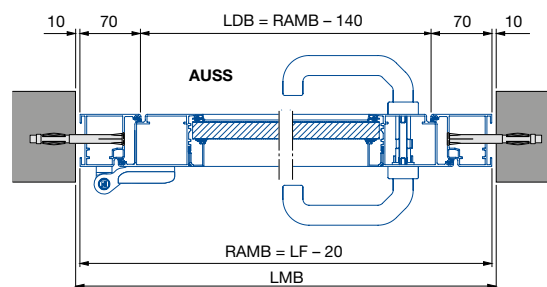
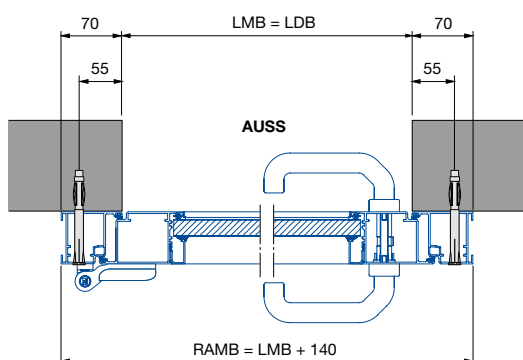
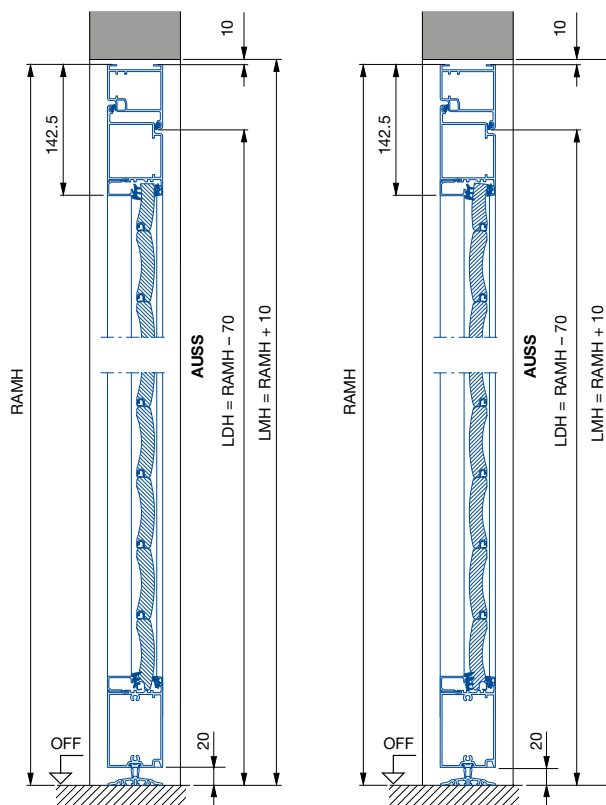

- AUSS** Exterior
- BRB** Nominal size width
- BRH** Nominal height
- LML** Structural opening width
- LMH** Structural opening height
- LDB** Clear passage width
- LDH** Clear passage height
- RAMB** Overall frame width (ordering size)
- RAMH** Overall frame height (ordering size)

# NT 60 side doors

For roller garage door RollMatic / garage horizontal door RollMatic OD  
single-leaf side doors with block frame made of aluminium profiles



Subject to changes

## Product description

### Fitting dimensions

#### Fitting in the opening (opening outwards)

Matching  
Internal roller garage doors  
RollMatic  
Overhead garage doors  
RollMatic OD

Matching  
External roller garage doors  
RollMatic

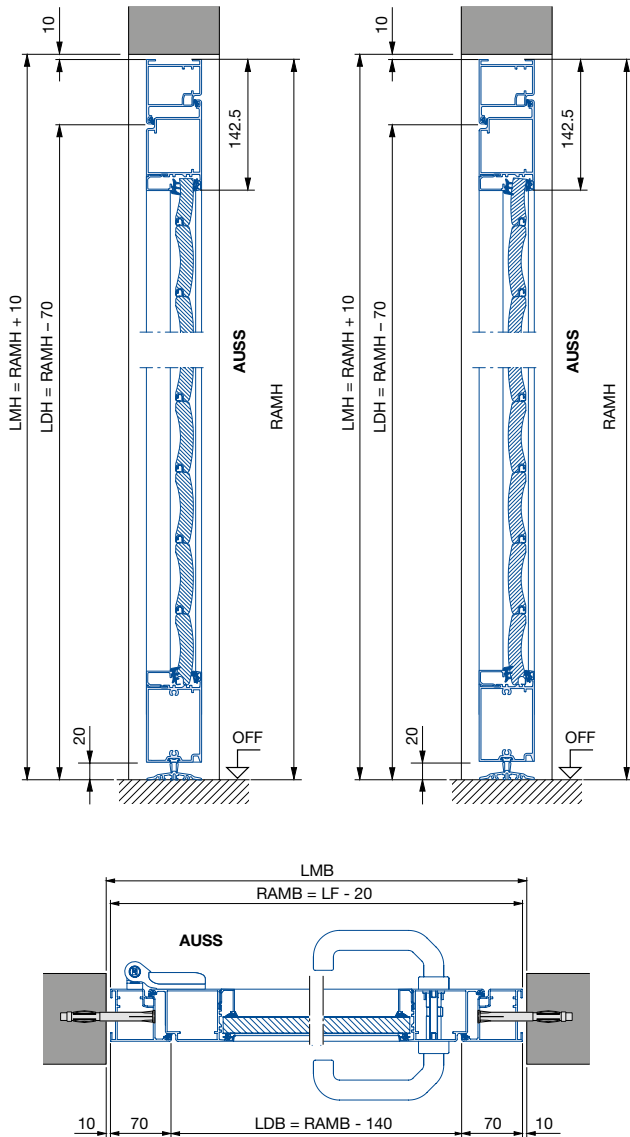



<b>AUSS</b>	Exterior
<b>BMB</b>	Ordering size width
<b>BMH</b>	Ordering size height
<b>BRB</b>	Nominal size width
<b>BRH</b>	Nominal height
<b>LML</b>	Structural opening width
<b>LMH</b>	Structural opening height
<b>LDB</b>	Clear passage width
<b>LDH</b>	Clear passage height
<b>RAMB</b>	Overall frame width (ordering size)
<b>RAMH</b>	Overall frame height (ordering size)

## NT 60 side doors

For RollMatic roller garage door / RollMatic OD overhead garage door  
single-leaf side doors with corner frame made of aluminium profiles



### Size range and prices

For a product description, see page 46			
<b>Size range</b> <b>Ordering sizes</b> Nominal sizes  Width × Height			
	<b>White or Color</b>	<b>Golden Oak / Rosewood</b>	<b>Golden Oak or Rosewood</b>
<b>Opening inwards or outwards</b>			
From 875 × 1800			
Up to 1200 × 2255	<b>1270</b>	<b>1392</b>	<b>1607</b>
From 1201 × 2256			
Up to 1284 × 2500	<b>1326</b>	<b>1443</b>	<b>1682</b>

**Note:**

View of internal roller garage door / external roller garage door, state opening sense and handing!



Noir 2100 Sablé			£
Door leaf / frame exterior and interior in colour Noir 2100 Sablé	Surcharge on white	Per door	<b>393</b>
Door leaf / frame exterior and interior in colour Chartwell Green	Surcharge on white	Per door	<b>778</b>

## NT 60 side doors

For roller garage door RollMatic / garage horizontal door RollMatic OD  
single-leaf side doors with block frame made of aluminium profiles

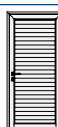

### Size range and prices

For a product description, see page 46			
<b>Size range</b> <b>Ordering sizes</b> Overall frame dimensions (RAM)  Width × Height			
	<b>White or Color</b>	<b>Golden Oak / Rosewood</b>	<b>Golden Oak or Rosewood</b>
<b>Opening inwards or outwards</b>			
From 855 × 1800			
Up to 1200 × 2255	<b>1284</b>	<b>1400</b>	<b>1623</b>
From 1201 × 2256			
Up to 1330 × 2558	<b>1326</b>	<b>1443</b>	<b>1682</b>

**Note:**



View of internal roller garage door / external roller garage door, state opening sense and handing!

Noir 2100 Sablé			£
Door leaf / frame exterior and interior in colour Noir 2100 Sablé	Surcharge on white	Per door	<b>393</b>
Door leaf / frame exterior and interior in colour Chartwell Green	Surcharge on white	Per door	<b>778</b>

# Accessories and optional extras

For NT 60 side doors

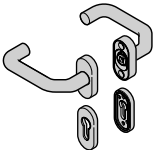
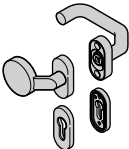
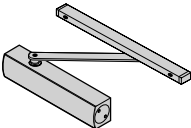
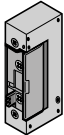
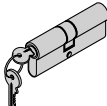

Glazing element		£
	Glazing element with clear synthetic pane, window cut-out 112 x 33 mm, black glazing frame on exterior, transparent on interior The number of glazing elements is dependent on the door width (not possible in the bottom section and in the lock area)	Per m <b>46</b>
Ventilation grille		£
	Ventilation grille, black plastic Ventilation cross-section: approx. 13 cm <sup>2</sup> /grille The number of ventilation grilles is dependent on the door width (not possible in the bottom section and in the lock area)	Per m <b>46</b>
Smaller overall frame dimensions		£
	Side door in smaller dimensions than special sizes	Per door <b>600</b>
Frame fixing (optional)		£
	Support bracket for block frame	Per set <b>38</b>
	Screw-in anchor for corner frame	Per set <b>40</b>
Fittings		£
Lever handle sets		
	Cast aluminium with natural finish (F1), prepared for profile cylinder	per unit <b>166</b>
	Cast aluminium in RAL 9016, prepared for profile cylinder	per unit <b>203</b>
	Cast aluminium in black, prepared for profile cylinder	per unit <b>203</b>
	Brushed stainless steel, prepared for profile cylinder	per unit <b>220</b>
Lever / knob handle sets		
	Black plastic, prepared for profile cylinder	per unit <b>92</b>
	Cast aluminium with natural finish (F1), prepared for profile cylinder	per unit <b>194</b>
	Cast aluminium in RAL 9016, prepared for profile cylinder	per unit <b>241</b>
	Cast aluminium in black, prepared for profile cylinder	per unit <b>241</b>
	Brushed stainless steel, prepared for profile cylinder	per unit <b>256</b>
Overhead door closer		
	Overhead door closer with slide rail and hold-open device	per unit <b>383</b>
3-point locking		
	3-point locking with latch, bolt, and 2 locking hooks; keys to differ Cannot be retrofitted!	Per door <b>587</b>
Electric door strike with day and night setting (without wiring). For doors with block frame made of aluminium profiles.		
	10 – 24 V, LH hinged / RH hinged (only opens with an impulse, i.e. as long as the button is pressed)	per unit <b>145</b>
	10 – 24 V, LH hinged / RH hinged (remains open after impulse until the door is actuated, subsequent locking by door strike)	per unit <b>194</b>
Block reed contact		
	Block reed contact (article no. 4004810)	per unit <b>142</b>
Anti-panic locks		£
<b>Anti-panic lock function E</b>	For profile cylinders, for fixed knob on outside, the door can only be opened from the outside using a key.	per unit <b>292</b>
Profile double cylinder		£
	Profile double cylinder <b>40 + 40 mm</b> Keys to pass, for side doors NT 60	<b>On request</b>

# Accessories and optional extras

For NT 60 side doors







Cleaning and care		Article no.		£
Cleaning cloth	Cleaning cloth (size 40 × 50 cm) Ready-to-use microfibre cloth for matt, glossy, film-coated and printed surfaces.	4018988	per unit	11
Cleaning and maintenance set	Content 1 × cleaner, 1 × cleaning sponge, 1 × 2-in-1 polish, 1 × polishing sponge, 2 × microfibre cloth, 1 × oil	4020356	Per set	78

NEW. Frame fastening bolts without head (without dowel hole)		Article no.		£
Set of frame fastening bolts 7.5 × 132 (9 × per set), not for RC2!		4024001	Per set	7
Set of frame fastening bolts 7.5 × 182 (9 × per set), not for RC2!		4024002	Per set	12
Set of frame fastening bolts 11 × 132 for RC2 (9 × per set)		4024003	Per set	18
Set of frame fastening bolts 11 × 182 for RC2 (9 × per set)		4024004	Per set	23

# Garage Door Operators





## Operator Accessories



Garage door operators				
Boom Length				
	SupraMatic E	SupraMatic P	ProMatic	ProMatic Akku
K	691	769	561	918
M	730	808	600	957
L	851	929	721	1078

Hand transmitters with BiSecur technology are backwards compatible, i.e. they can also be used with series 1 and 2 operators (868 MHz). Hand transmitter 868 MHz BiSecur, incl. battery (Range of radio signal depends on local conditions)

- Possible
- Only in combination with a BiSecur radio receiver
- Only in conjunction with the BiSecur radio receiver ESE, status query possible
- Not possible

Accessory	Description	Garage door operators				
		SupraMatic E / P	SupraMatic HT	ProMatic	ProMatic Akku	RollMatic
<b>HS</b> 1-button hand transmitter  Black <b>HS 1 BS</b> Art. no. 4511720 £ 82	<b>Textured plastic surface with chrome-plated zinc die-cast caps</b> <ul style="list-style-type: none"> <li>• Impulse</li> <li>• Protection category: for dry rooms only</li> <li>• Temperature range: -20 °C to +60 °C</li> <li>• Battery: 1.5 V LR03 / AAA</li> <li>• Dimensions: 38 x 95 x 16 mm</li> </ul>	●	●	●	●	●
<b>HS</b> 4-button hand transmitter  Black <b>HS 4 BS</b> Art. no. 4511724 £ 82	<b>Textured plastic surface with chrome-plated zinc die-cast caps</b> <ul style="list-style-type: none"> <li>• Impulse</li> <li>• Protection category: for dry rooms only</li> <li>• Temperature range: -20 °C to +60 °C</li> <li>• Battery: 1.5 V LR03 / AAA</li> <li>• Dimensions: 38 x 95 x 16 mm</li> </ul>	●	●	●	●	●
<b>HS</b> 5-button hand transmitter  Black <b>HS 5 BS</b> Art. no. 436946 £ 98	<b>Textured plastic surface with chrome-plated zinc die-cast caps</b> <ul style="list-style-type: none"> <li>• Impulse</li> <li>• Status query</li> <li>• Protection category: for dry rooms only</li> <li>• Temperature range: -20 °C to +60 °C</li> <li>• Battery: 1.5 V LR03 / AAA</li> <li>• Dimensions: 38 x 95 x 16 mm</li> </ul>	●	●	●	●	-
<b>HS</b> 5-button hand transmitter  Black                      White <b>HS 5 BS</b> <b>HS 5 BS</b> Art. no. 436752                      436753 £ 98                                      98	<b>High gloss plastic surface with chrome-plated zinc die-cast caps</b> <ul style="list-style-type: none"> <li>• Impulse</li> <li>• Status query</li> <li>• Protection category: for dry rooms only</li> <li>• Temperature range: -20 °C to +60 °C</li> <li>• Battery: 1.5 V LR03 / AAA</li> <li>• Dimensions: 38 x 95 x 16 mm</li> </ul>	●	●	●	●	-



# Garage Door Operators

## Operator Accessories



Hand transmitters with BiSecur technology are backwards compatible, i.e. they can also be used with series 1 and 2 operators (868 MHz). Hand transmitter 868 MHz BiSecur, incl. battery (Range of radio signal depends on local conditions)

- Possible
- Only in combination with a BiSecur radio receiver
- Only in conjunction with the BiSecur radio receiver ESE, status query possible
- Not possible

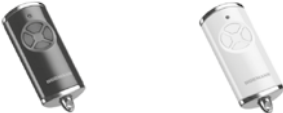
Accessory		Description		Garage door operators																									
				SupraMatic E/P	SupraMatic HT	ProMatic	ProMatic Akku	RollMatic																					
<b>HSI</b> Industrial hand transmitter  <p>Black      Black      Black</p> <table border="1"> <thead> <tr> <th></th> <th>HSI 3 BS</th> <th>HSI 6 BS</th> <th>HSI 15 BS</th> </tr> </thead> <tbody> <tr> <td>Art. no.</td> <td>635058</td> <td>4511773</td> <td>4511774</td> </tr> <tr> <td>£</td> <td>116</td> <td>143</td> <td>207</td> </tr> </tbody> </table>			HSI 3 BS	HSI 6 BS	HSI 15 BS	Art. no.	635058	4511773	4511774	£	116	143	207	<ul style="list-style-type: none"> <li>Impulse</li> <li>Protection category: IP 65</li> </ul> <p><b>HSI 3 BS“</b></p> <ul style="list-style-type: none"> <li>For controlling up to 3 receivers</li> <li>Dimensions (W x H x D): 36 x 74 x 16 mm</li> <li>Battery: 2 x CR2025</li> <li>Temperature range: -10°C to +60°C</li> <li>Incl. belt clip and hand transmitter strap</li> </ul> <p><b>HSI 6 BS“</b></p> <ul style="list-style-type: none"> <li>For controlling up to 6 receivers</li> <li>Dimensions (W x H x D): 50 x 90 x 25 mm</li> <li>Battery: 2 x 1.5 V LR03 / AAA</li> <li>Temperature range: -20°C to +60°C</li> <li>Incl. belt clip and lanyard</li> </ul> <p><b>HSI 15 BS“</b></p> <ul style="list-style-type: none"> <li>For controlling up to 15 receivers</li> <li>Dimensions (W x H x D): 65 x 133 x 25 mm</li> <li>Battery: 4 x 1.5 V LR03/AAA</li> <li>Temperature range: -20°C to +60°C</li> <li>Incl. belt clip and lanyard</li> </ul>					●	●	●	●	●						
	HSI 3 BS	HSI 6 BS	HSI 15 BS																										
Art. no.	635058	4511773	4511774																										
£	116	143	207																										
<b>Accessories</b> Hand transmitter holder  <table border="1"> <thead> <tr> <th></th> <th>For HSI 3 BS</th> <th>For HSI 6 BS</th> <th>For HSI 15 BS</th> </tr> </thead> <tbody> <tr> <td>Art. no.</td> <td>635059</td> <td>437383</td> <td>437384</td> </tr> <tr> <td>£</td> <td>11</td> <td>11</td> <td>16</td> </tr> </tbody> </table>			For HSI 3 BS	For HSI 6 BS	For HSI 15 BS	Art. no.	635059	437383	437384	£	11	11	16	<ul style="list-style-type: none"> <li>Hand transmitter holder</li> <li>Fitting accessories for mounting to the wall or tubular frame</li> </ul>															
	For HSI 3 BS	For HSI 6 BS	For HSI 15 BS																										
Art. no.	635059	437383	437384																										
£	11	11	16																										
<b>HSE</b> 1-button hand transmitter  <p>Black</p> <table border="1"> <thead> <tr> <th></th> <th>HSE 1 BS</th> </tr> </thead> <tbody> <tr> <td>Art. no.</td> <td>4511728</td> </tr> <tr> <td>£</td> <td>82</td> </tr> </tbody> </table>			HSE 1 BS	Art. no.	4511728	£	82	<p><b>Textured plastic surface with chrome-plated zinc die-cast caps</b></p> <ul style="list-style-type: none"> <li>Impulse</li> <li>Incl. key ring for fastening to the key chain</li> <li>Protection category: for dry rooms only</li> <li>Temperature range: 0 °C to +60 °C</li> <li>Battery: Lithium round cell 3 V / type CR 2032</li> <li>Dimensions: 28 x 70 x 14 mm</li> </ul>					●	●	●	●	●												
	HSE 1 BS																												
Art. no.	4511728																												
£	82																												
<b>HSE</b> 4-button hand transmitter  <p>Black      White</p> <table border="1"> <thead> <tr> <th></th> <th>HSE 4 BS</th> <th>HSE 4 BS</th> </tr> </thead> <tbody> <tr> <td>Art. no.</td> <td>4511561</td> <td>4511565</td> </tr> <tr> <td>£</td> <td>82</td> <td>82</td> </tr> </tbody> </table>			HSE 4 BS	HSE 4 BS	Art. no.	4511561	4511565	£	82	82	<p><b>High-gloss plastic surface with chrome-plated zinc diecast caps</b></p> <ul style="list-style-type: none"> <li>Impulse</li> <li>Incl. key ring for fastening to the key chain</li> <li>Protection category: for dry rooms only</li> <li>Temperature range: 0 °C to +50 °C</li> <li>Battery: Lithium round cell 3 V / type CR 2032</li> <li>Dimensions: 28 x 70 x 14 mm</li> </ul>					●	●	●	●	●									
	HSE 4 BS	HSE 4 BS																											
Art. no.	4511561	4511565																											
£	82	82																											
<b>HSE</b> 4-button hand transmitter HSE 4 BS <table border="1"> <thead> <tr> <th>Housing colour</th> <th>Art. no.</th> <th>£</th> </tr> </thead> <tbody> <tr> <td>Anthracite grey</td> <td>4511573</td> <td>98</td> </tr> <tr> <td>Frozen grey</td> <td>4511569</td> <td>98</td> </tr> <tr> <td>Classic grey</td> <td>4511577</td> <td>98</td> </tr> <tr> <td>Carbon</td> <td>4511585</td> <td>98</td> </tr> <tr> <td>Silver</td> <td>4511581</td> <td>98</td> </tr> </tbody> </table>		Housing colour	Art. no.	£	Anthracite grey	4511573	98	Frozen grey	4511569	98	Classic grey	4511577	98	Carbon	4511585	98	Silver	4511581	98										
Housing colour	Art. no.	£																											
Anthracite grey	4511573	98																											
Frozen grey	4511569	98																											
Classic grey	4511577	98																											
Carbon	4511585	98																											
Silver	4511581	98																											





# Garage Door Operators

## Operator Accessories



Hand transmitters with BiSecur technology are backwards compatible, i.e. they can also be used with series 1 and 2 operators (868 MHz). Hand transmitter 868 MHz BiSecur, incl. battery (Range of radio signal depends on local conditions)

- Possible
- Only in combination with a BiSecur radio receiver
- Only in conjunction with the BiSecur radio receiver ESE, status query possible
- Not possible

Accessory		Description	Garage door operators				
			SupraMatic E/P	SupraMatic HT	ProMatic	ProMatic Akku	RollMatic
<b>HSE</b> 4-button hand transmitter  Black <b>HSE 4 BS</b> Art. no. 4511732 £ 82		<b>Textured plastic surface with chrome-plated zinc die-cast caps</b> <ul style="list-style-type: none"> <li>• Impulse</li> <li>• Incl. key ring for fastening to the key chain</li> <li>• Protection category: for dry rooms only</li> <li>• Temperature range: 0 °C to +60 °C</li> <li>• Battery: Lithium round cell 3 V / type CR 2032</li> <li>• Dimensions: 28 × 70 × 14 mm</li> </ul>	●	●	●	●	●
<b>HSE</b> 4-button hand transmitter  Black <b>HSE 4 BS</b> Art. no. 4511736 £ 74		<b>Textured plastic surface with plastic caps</b> <ul style="list-style-type: none"> <li>• Impulse</li> <li>• Incl. key ring for fastening to the key chain</li> <li>• Protection category: for dry rooms only</li> <li>• Temperature range: 0 °C to +60 °C</li> <li>• Battery: Lithium round cell 3 V / type CR 2032</li> <li>• Dimensions: 28 × 70 × 14 mm</li> </ul>	●	●	●	●	●
<b>Accessories</b> For hand transmitter (HSE)  <b>Hand transmitter holder</b> Art. no. 437006 £ 14		<ul style="list-style-type: none"> <li>• For HSE 1 BS, HSE 2 BS and HSE 4 BS</li> <li>• Transparent, incl. visor clip</li> <li>• For wall fitting or for fitting to the visor clip</li> <li>• without fixing material</li> </ul>					
<b>HSD</b>  Chrome <b>HSD 2-C BS</b> Art. no. 436775 £ 117		<ul style="list-style-type: none"> <li>• Impulse</li> <li>• High-quality metal housing</li> <li>• As a key ring</li> <li>• Protection category: for dry rooms only</li> <li>• Temperature range: 0 °C to +60 °C</li> <li>• Battery: Lithium round cell 3 V / type CR 2025</li> <li>• Dimensions (W × H × D): 32 × 66 × 13 mm</li> </ul>	●	●	●	●	●
<b>HSZ</b> 1-button hand transmitter      2-button hand transmitter   Black      Black <b>HSZ 1 BS</b> <b>HSZ 2 BS</b> Art. no. 436779      436782 £ 74      74		<ul style="list-style-type: none"> <li>• Impulse</li> <li>• For insertion in a vehicle cigarette lighter</li> <li>• Protection category: for dry rooms only</li> <li>• Temperature range: -20 °C to +60 °C</li> <li>• Battery: Lithium 3 V / type CR 2</li> <li>• Dimensions (D × H): Ø 29 × 39 mm</li> </ul>	●	●	●	●	●

# Garage Door Operators

## Operator Accessories





Hand transmitters with BiSecur technology are backwards compatible, i.e. they can also be used with series 1 and 2 operators (868 MHz). Hand transmitter 868 MHz BiSecur, incl. battery (Range of radio signal depends on local conditions)

- Possible
- Only in combination with a BiSecur radio receiver
- Only in conjunction with the BiSecur radio receiver ESE, status query possible
- Not possible

### Garage door operators

SupraMatic E/P	SupraMatic HT	ProMatic	ProMatic Akku	RollMatic
----------------	---------------	----------	---------------	-----------

### Radio internal push button / internal receiver

<p><b>FIT</b> 1-button radio internal push button</p>  <p>Art. no. <b>FIT 1 BS</b> 4556696</p> <p>£ <b>122</b></p>	<ul style="list-style-type: none"> <li>• Protection category: for dry rooms only</li> <li>• Temperature range: -20 °C to +60 °C</li> <li>• Battery: 2 x 1.5 V LR03 / AAA</li> <li>• Colour: Pure white RAL 9010</li> <li>• Dimensions (W x H x D): 80 x 80 x 15 mm</li> <li>• Screw and adhesive fixing</li> </ul>	<table border="1"> <tr> <td>●</td> <td>●</td> <td>●</td> <td>●</td> <td>●</td> </tr> </table>	●	●	●	●	●
●	●	●	●	●			
<p><b>FIT</b> 4-button radio internal push button</p>  <p>Art. no. <b>FIT 4 BS</b> 4556697</p> <p>£ <b>122</b></p>	<ul style="list-style-type: none"> <li>• Impulse</li> <li>• Protection category: for dry rooms only</li> <li>• Temperature range: -20 °C to +60 °C</li> <li>• Battery: 2 x 1.5 V LR03 / AAA</li> <li>• Colour: Pure white RAL 9010</li> <li>• Dimensions (W x H x D): 80 x 80 x 15 mm</li> <li>• Screw and adhesive fixing</li> </ul>	<table border="1"> <tr> <td>●</td> <td>●</td> <td>●</td> <td>●</td> <td>●</td> </tr> </table>	●	●	●	●	●
●	●	●	●	●			
<p><b>FIT</b> 5-button radio internal push button</p>  <p>Art. no. <b>FIT 5 BS</b> 4556698</p> <p>£ <b>143</b></p>	<ul style="list-style-type: none"> <li>• Impulse</li> <li>• Status query</li> <li>• Protection category: for dry rooms only</li> <li>• Temperature range: -20 °C to +60 °C</li> <li>• Battery: 2 x 1.5 V LR03 / AAA</li> <li>• Colour: Pure white RAL 9010</li> <li>• Dimensions (W x H x D): 80 x 80 x 15 mm</li> <li>• Screw and adhesive fixing</li> </ul>	<table border="1"> <tr> <td>●</td> <td>●</td> <td>●</td> <td>●</td> <td>●</td> </tr> </table>	●	●	●	●	●
●	●	●	●	●			

### Internal push button

<p><b>IT 3b-1 M</b> Internal push button</p>  <p>Art. no. <b>IT 3b-1 Motion</b> 4556758</p> <p>£ <b>128</b></p>	<ul style="list-style-type: none"> <li>• Impulse</li> <li>• Operator light switched on via movement detector</li> <li>• Additional buttons for light on / off, operator on / off (vacation mode) and movement detector on / off</li> <li>• Illuminated keypad</li> <li>• With 7 m connecting lead, 2-wire</li> <li>• Protection category: for dry rooms only</li> <li>• Temperature range: -20 °C to +50 °C</li> <li>• Colour: Pure white RAL 9010</li> <li>• Dimensions (W x H x D): 80 x 80 x 45 mm</li> </ul>	<table border="1"> <tr> <td>●</td> <td>●</td> <td>●</td> <td>-</td> <td>●</td> </tr> </table>	●	●	●	-	●
●	●	●	-	●			

# Garage Door Operators

## Operator Accessories



Hand transmitters with BiSecur technology are backwards compatible, i.e. they can also be used with series 1 and 2 operators (868 MHz). Hand transmitter 868 MHz BiSecur, incl. battery (Range of radio signal depends on local conditions)

- Possible
- Only in combination with a BiSecur radio receiver
- Only in conjunction with the BiSecur radio receiver ESE, status query possible
- Not possible

### Garage door operators

SupraMatic E/P	SupraMatic HT	ProMatic	ProMatic Akku	RollMatic
----------------	---------------	----------	---------------	-----------

#### Radio internal push button 868 MHz BiSecur, incl. battery (Range of radio signal depends on local conditions)

**FCT** Radio code switch



**FCT 3-1 BS**

Art. no. 4511857  
£ 146

- Impulse
- for control of up to 3 door operators
- Illuminated keyboard
- Activation on push of button
- Protection category: IP 44
- Temperature range: -20°C to +50°C
- Power supply: Battery 2 x 1.5 V LR03 / AAA
- Housing: Plastic, colour Light grey RAL 7040

**FCT 3-1 BS (recessed):**

- Dimensions (W x H x D): 80 x 80 x 15 mm

**FCT 3-1 BS (surface-mounted):**

- Dimensions (W x H x D): 80 x 80 x 30 mm

**FCT** Radio code switch



**FCT 10-1 BS**

Art. no. 4511862  
£ 219

- Impulse
- for control of up to 10 door operators
- Illuminated keyboard, hinged lid
- Automatic activation on opening the lid or by pushing the button
- Protection category: IP 44
- Temperature range: -20°C to +50°C
- Power supply: Battery 2 x 1.5 V LR03 / AAA
- Housing: Plastic, painted, colour White aluminium RAL 9006

**FCT 10-1 BS (recessed):**

- Dimensions (W x H x D): 80 x 80 x 20 mm

**FCT 10-1 BS (surface-mounted):**

- Dimensions (W x H x D): 80 x 80 x 35 mm

**CTR** Code switch



1 relay output      3 separate relay outputs

**CTR 1b-1**

**CTR 3b-1**

Art. no. 4511671      4511672  
£ 267      308

- Impulse
- Illuminated keyboard
- With 5 m connecting cable between the input unit and the decoder
- Operating voltage: optionally 100–240 V AC or 10–24 V AC/DC
- Max. switching capacity:
  - 30 V DC / 2.5 A (resistive load)
  - 230 V AC / 500 W (resistive load)
- Protection category:
  - Input unit IP 65
  - Decoder unit IP20
- Temperature range: -20°C to +60°C
- Input unit dimensions (W x H x D): 80 x 80 x 15 mm  
Decoder unit dimensions (W x H x D): 140 x 130 x 50 mm
- Without connecting lead, connection cables for power supply
  - 230 V AC: Use connection cable ZL 1
  - 24 V AC / DC and for providing impulse to operator: Use ASL connection cables. Use ASL connection cables
- **CTR 1b-1: 1** relay output for control of one door operator  
**CTR 3b-1: 3** separate relay outputs for control of 2 operators, second opening height, outdoor lighting

**CTP** Code switch



3 separate relay outputs

**CTP 3-1**

Art. no. 4511674  
£ 366

- Illuminated capacitive keyboard
- Impulse
- With 5 m connecting cable between the input unit and the decoder
- Operating voltage: optionally 100–240 V AC or 10–24 V AC/DC
- Max. switching capacity:
  - 30 V DC / 2.5 A (resistive load)
  - 230 V AC / 500 W (resistive load)
- 3 separate relay outputs for control of 2 operators, second opening height, outdoor lighting
- Protection category:
  - Input unit IP 65
  - Decoder unit IP20
- Temperature range: -20°C to +60°C
- Input unit dimensions (W x H x D): 80 x 80 x 15 mm  
Decoder unit dimensions (W x H x D): 140 x 130 x 50 mm
- Without mains lead, connection cables for power supply
  - 230 V AC: Use connection cable ZL 1
  - 24 V AC / DC and for providing impulse to operator: Use ASL connecting leads

# Garage Door Operators

## Operator Accessories



Hand transmitters with BiSecur technology are backwards compatible, i.e. they can also be used with series 1 and 2 operators (868 MHz). Hand transmitter 868 MHz BiSecur, incl. battery (Range of radio signal depends on local conditions)

- Possible
- Only in combination with a BiSecur radio receiver
- Only in conjunction with the BiSecur radio receiver ESE, status query possible
- Not possible

### Garage door operators

SupraMatic E/P	SupraMatic HT	ProMatic	ProMatic Akku	RollMatic
----------------	---------------	----------	---------------	-----------

### Radio internal push button 868 MHz BiSecur, incl. battery (Range of radio signal depends on local conditions)

**FIT** Radio internal push button



- Impulse
- With 2 impulse push buttons for control of 2 operators via radio signal
- One additional button for On/Off function of connected external control elements
- Connection option for max. 2 control elements (volt-free contact) e.g. key switch
- Protection category: for dry rooms only
- Temperature range: -20°C to +60°C
- Battery: 2 x 1.5 V LR03/AAA
- Colour: Pure white RAL 9010
- Dimensions (W x H x D): 80 x 80 x 45 mm

**FIT 2-1 BS**

Art. no. 4511695  
£ 111

●	●	●	●	●
---	---	---	---	---

**IT 3b-1** Internal push button



- Impulse
- Additional buttons for light on/off and operator on/off (vacation mode)
- Illuminated keyboard
- With 7 m connection cable, 2-wire
- Protection category: for dry rooms only
- Temperature range: -20°C to +60°C
- Colour: Pure white RAL 9010
- Dimensions (W x H x D): 80 x 80 x 45 mm

**IT 3b-1**

Art. no. 4511647  
£ 57

●	●	●	-	●
---	---	---	---	---

### Radio finger-scan 868 MHz BiSecur (range of radio signal depends on local conditions!)

**FFL** Radio finger-scan



- Impulse
- To control up to 2 door operators using a fingerprint
- Up to 25 fingerprints can be taught in, cannot be individually deleted
- Hinged lid
- Automatic activation on opening the lid or by pushing the "ON" button
- Protection category: IP 44
- Temperature range: -20°C to +50°C
- Power supply: Battery 2 x 1.5 V LR03 / AAA
- Housing: Plastic, painted, colour White aluminium RAL 9006

**FFL 25 BS (recessed):**

- Dimensions (W x H x D): 80 x 80 x 20 mm

**FFL 25 BS (surface-mounted):**

- Dimensions (W x H x D): 80 x 80 x 35 mm

**FFL 25 BS**

Art. no. 4511865  
£ 288

●	●	●	●	●
---	---	---	---	---

### Batteries

### Description

**HNA** Emergency battery



- Emergency power supply to bypass power failures up to 18 hours and max. 5 door cycles (depending on temperatures, situation of charge etc.)
- To be fixed on operator or garage ceiling
- Protection category: for dry rooms only
- Weight: approx. 2.3 kg
- Operating voltage: 24 V DC / 2.3 Ah
- Dimensions (W x H x D): 150 x 70 x 90 mm

Also suitable for series 2 SupraMatic and ProMatic operators.

**HNA 18-4**

Art. no. 4510095  
£ 288

●	●	●	-	-
---	---	---	---	---





## Lighting/Safety technology

- Possible
- Only in conjunction with a BiSecur radio receiver
- Only in conjunction with the BiSecur radio receiver ESE, status query possible
- Not possible



### Garage door operators

SupraMatic E / P	SupraMatic HT	ProMatic	ProMatic Akku	RollMatic
------------------	---------------	----------	---------------	-----------

#### LED strips

##### LED strips

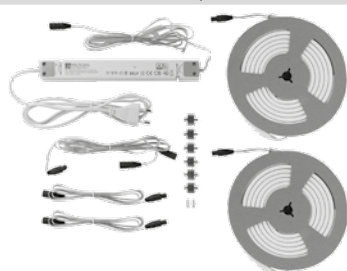

- Light colour: neutral-white, bright natural-quality lighting for the garage  
Colour temperature: 4000 K
- Simple fitting on the guide rails of the garage door and the existing cross struts, magnetic attachment
- Variable arrangement up to door widths of 6000 mm
- Protection category: IP 65

##### LED strip garage lighting

Art. no. 4556539

£ 194

##### LED strip garage lighting, including option relay HOR1-HCP

Art. no. 4556540

£ 258

#### Note:

- Power supply unit (article no. 436534) is also required and must be ordered separately!

#### Alarm sensor

##### Hörmann alarm sensor



- Alarm sensor with alarm encoder and sirens
- Alarm in case of attempted break-in when the garage door is opened by force
- Securing of sectional doors in ventilation position / partial opening / close
- Acoustic signal at 110 db when door system tampering is detected

##### HAS 1

Art. no. 4556905

£ 134

## Notes and sketches

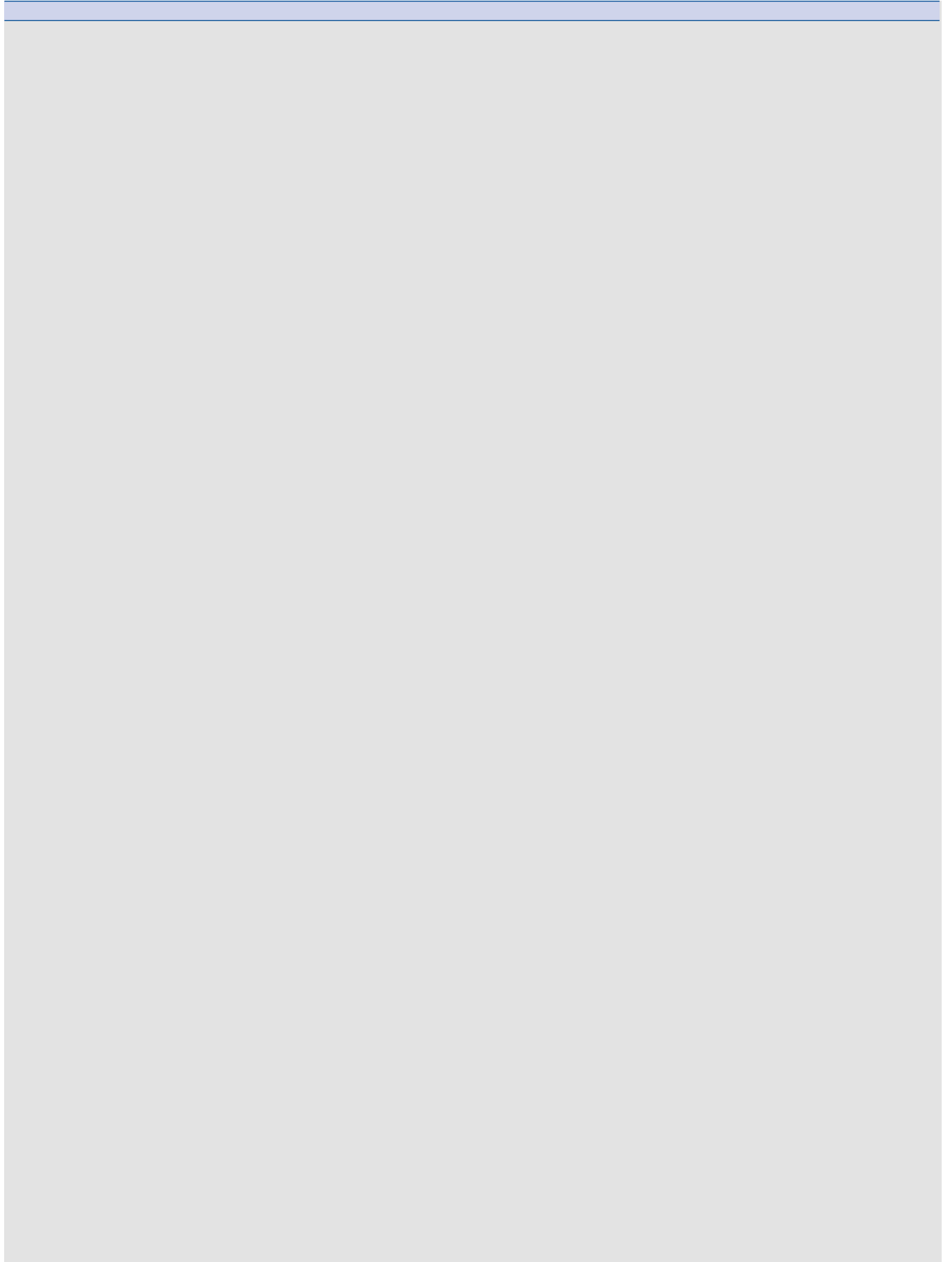

## Notes and sketches

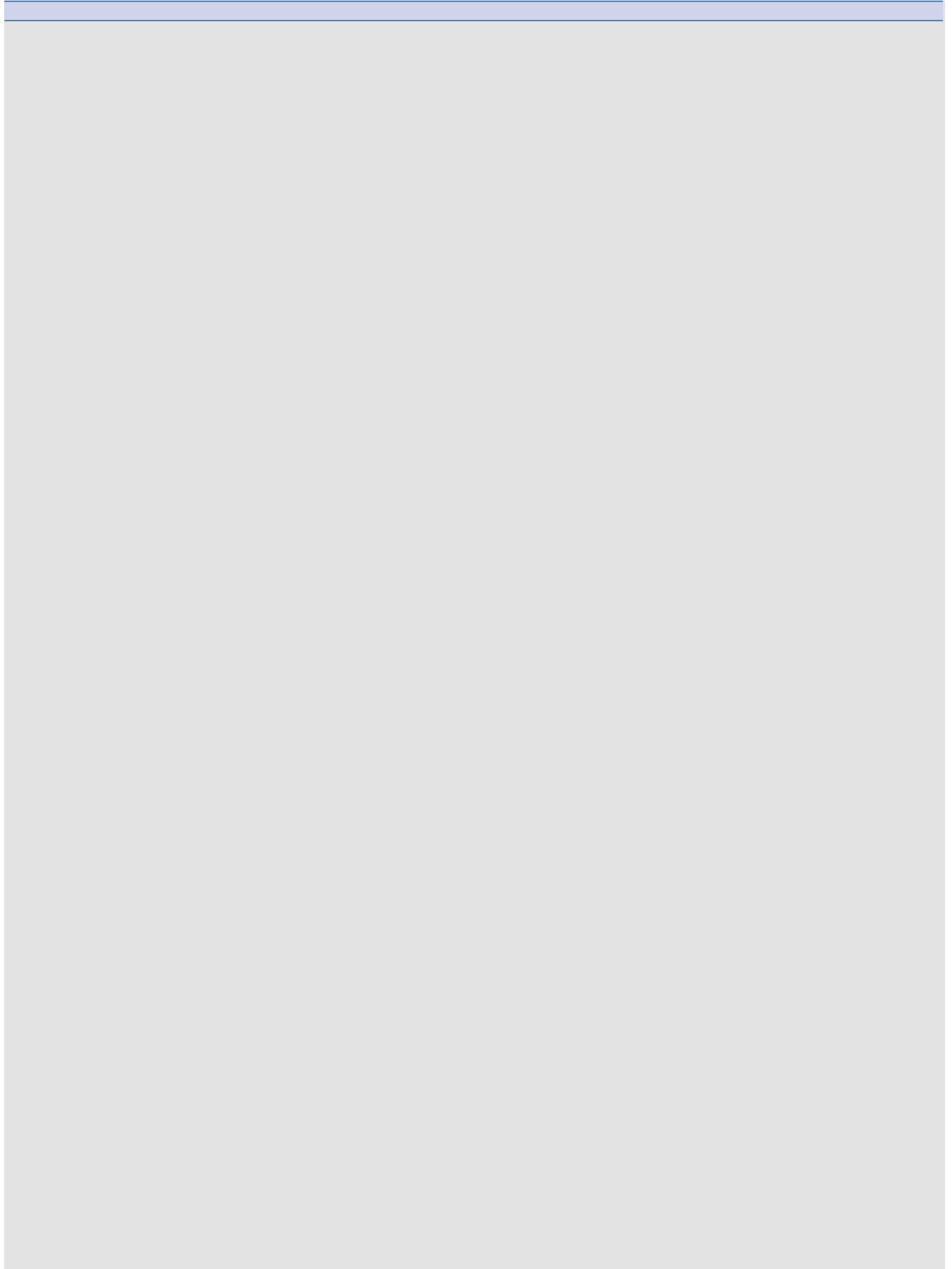

# Warranty

Hörmann products are manufactured to the highest quality standards and leave our factory only after rigorous quality testing. However, if you should have grounds for complaint, this section tells you what our door warranty offers, and how to go about making your claim.

In the unlikely event of a warranty claim becoming necessary, please contact the dealer or distributor who originally supplied your garage door. Your dealer should then supply details of the claim, together with a copy of the warranty card provided with the door and proof of purchase to the Product Services Department at Hörmann (UK) Ltd. To enable your claim under warranty to be processed as quickly as possible, you should provide the following details:

1. Your name, address and telephone number
2. Original invoice with date of purchase
3. Product description/door type and product number
4. Description of defect

An assessment of the claim will then be made. This may require Hörmann to inspect the product in-situ. In the event that there is no legitimate warranty claim under the terms specified herein, you may be liable for the costs of the inspection visit. We strongly recommend that you take note of the care and usage instructions displayed on the stickers on the back of your garage door, and on the page opposite, and that you follow these instructions throughout.

## Hörmann installers

Hörmann (UK) Ltd has a nationwide network of recommended installers who will be able to offer you a regular maintenance service on your garage door. Please call us on 01530 513050 for details of your nearest dealer.

## The Quality Check

A new garage door can be a significant investment that will transform the appearance of your home. This information is a guide to the quality you can expect.

## Hörmann (UK) Ltd Garage Door Warranty

<b>Warranty Period</b>	The purchaser is granted a warranty covering the safe and reliable function of the Hörmann garage door for a period of 10 years from the date of purchase. A 5 year warranty applies to springs, wire cables, track rollers, hinges and guide rollers. The warranty period for replacement parts is 6 months or to the end of the current warranty period, whichever is longer. In the case of foil-coated timber-effect, a warranty of 5 years is granted on the door panels alone under the terms and conditions specified herein. The door mechanism and steel frame (if applicable) is covered by the 10 year warranty period.
<b>Requirements</b>	Warranty claims are only applicable in the country where the garage door was purchased. The product must have been purchased through our authorised distribution channels. The warranty only covers damage to the contract object. The fully completed warranty card together with the receipt of purchase correspondingly dated substantiates your right to claim under the warranty.
<b>Performance</b>	During the warranty period we undertake to rectify any and all defects to the Hörmann product which can be proved to be attributed to a material or manufacturing fault. We pledge at our discretion either to exchange the defective merchandise for faultless merchandise, repair it or allow a reduction in price. We do not accept costs for dismantling and installation nor for carriage. Replaced parts become our property. The warranty does not cover damage caused through: <ul style="list-style-type: none"><li>• normal wear and tear</li><li>• improper installation</li><li>• negligent care and maintenance</li><li>• improper initial and subsequent operation</li><li>• negligent or wanton destruction</li><li>• external influences such as fire, water, salts, alkaline solutions, acids, abnormal environmental influences</li><li>• mechanical damage through improper transport and fitting</li><li>• priming and other surface protection treatments</li><li>• incorrect or too late applied surface protection treatments</li><li>• repair by non-qualified persons</li><li>• using non-Hörmann parts without the approval of the manufacturer</li><li>• removal of the product number or making it unidentifiable</li></ul>

## Electric Operator Warranty

A separate 5 year warranty is granted on our electric operators. This includes operator mechanics, motor and motor control systems. A 2 year warranty is granted on radio equipment, accessories and system controls. There is no warranty on consumables (e.g. fuses, batteries, bulbs etc.). For further details please contact us on 01530 513030 or through our website on [www.hormann.co.uk](http://www.hormann.co.uk)

## User Information/Care

### Finish – Steel Doors

The coating process applied to the door and chassis is environmentally friendly. Minor scratches or marks are not covered under the conditions of our warranty and should be repaired immediately to prevent corrosion and deterioration of the panel. Corrosive substances such as acids, alkalines, and salts, etc. should be cleaned from the door immediately; failure to do so will result in deterioration of the finish, which will not be covered under our warranty. Should deterioration of the finish start to occur you will need to repaint your door immediately. Prepare the surface lightly with wet and dry. Then treat with solvent based 2 pack epoxy wash primer and a normal commercial paint (cellulose paint must not be used). Hörmann steel doors are a finished product. They do not require re-painting on site. They are however not immune to damage, which can occur at any stage of the handling of the product from factory to site.

### Paint Finish – Steel Doors

Minor surface damage can easily be repaired using touch up sprays or sticks without invalidating warranties.

# Extracts from DHF consumer advice

The following document was designed by the Association of Garage Door Specialists, updated by the DHF and endorsed by all major UK garage door manufacturers, as a guide for purchasers of domestic garage doors.

## Visual appearance of Garage Doors

A new garage door can be a significant investment that will transform the appearance of your home. This information is a guide to the quality you can expect.

### The Quality Check

The quality check should be carried out in natural daylight, not direct sunlight. Stand at a distance of 3 metres from the door to view the overall appearance. The door is acceptable if, taking into account the facts below, none of the following are readily visible on the face of the door:

- Marks or distortion associated with the manufacturing process
- Minor indentations, marks or scuffs on the surface
- Paint or stain blemishes

## The Facts

### Steel Doors

**Panel Distortion** The rolling or pressing of steel panels during manufacture will cause distortion in the steel and while every effort is made to keep this to a minimum, inevitably some visible distortion will remain. The application of high gloss paints will make this slight distortion more apparent, especially under certain lighting conditions, such as car headlamps, or bright sunshine.

**Paint Finish** Primed doors – the primer coating is applied as a base coat only and as such requires additional finishing with a good quality exterior paint. Any marks or scratches on the primer coat should be rubbed down and repainted as part of this finishing process.

### All Doors

**Colour Match** Pairs of doors should be ordered together to obtain the best colour match, bearing in mind the limitations of the materials used in the construction.

**Size Variation** As the size of a door changes in height and/or width, the panel frequency and profile can change, therefore doors of the same style but of different sizes can be significantly different in appearance.

**Clearances** All doors require operating clearances, i.e. the gap between the door panel and the frame opening, these are inbuilt during manufacture and should not be reduced by means of infills, or draughtproofing.

**Deflection** When in the open position, all doors will display a level of vertical deflection or “sag” across the width of the panel. Individual manufacturers’ specifications should be consulted for exact tolerances.

### Power Operated Garage Doors

It is against the law to install a power operated garage door in the UK without complying with the Machinery Directive.

To comply with the Machinery Directive both the door and the operator used in the installation must have a Declaration of Incorporation from the manufacturer.

On completion of the installation the installer must provide a Declaration of Conformity and apply a CE mark giving details of the installation to the door / operator combination, which is now classed as a machine.

The installer must issue to the customer a Declaration of Conformity on completion of the installation.

The installer must hold copies of both the Declaration of Incorporation and the Declaration of Conformity on a technical file for inspection by the relevant authorities.

If any of the above requirements are not fulfilled the installation is illegal.

Please ensure for your own safety and peace of mind that whoever installs your electric operator is both willing and able to fulfil these requirements; if they are not – do not use them!

Members of the DHF Garage Door Installer Group can and will install your Hörmann operator safely and legally.

Since the company's policy is one of continuous improvement of its products, we reserve the right to make any alterations in design, manufacture or price. All business is governed by the company's Standard Conditions and this document does not form any part of any contract with the company and statements contained in it should not be construed as representations or warranties.

# Brand quality for residential and commercial construction

The family-owned company Hörmann offers all important construction components for building and renovating projects from a single source. We manufacture in highly specialised factories using state-of-the-art production technologies. Furthermore, our employees work intensively on new products, continual further developments and improvements to details. The results are patents and one-of-a-kind products you can depend on.



01.01.2026 V.1

[www.hoermann.com](http://www.hoermann.com)

Hörmann (UK) Ltd  
Gee Road  
Coalville  
Leicestershire  
LE67 4JW

Tel: 01530 513000  
Fax: 01530 513001

[www.hormann.co.uk](http://www.hormann.co.uk)

**HÖRMANN**